

**telergon**  
gorlan

Cam switches



# Cam switches

series  
**T|TB|TF|TP**

Cam switches available in different construction models over a wide current range with a large variety of accessories.

According to:  
IEC 60947-3  
UL508 - CAN/CSA C22.2 N° 14  
RoHS

Testing and approvals:



Cam switches are manufactured in different series under strict quality controls to provide a reliable product that meets the most demanding requirements.

They consist of chambers, each containing up to two double break contacts of positive opening. These contacts silver alloy plated providing a long electromechanical life.

In sizes 0 - 1 and 2, the terminals are equipped with captive clamp screws to facilitate installation work, and all the connections themselves are covered to provide an IP20 protection rating.

The different configurations of contacts available provide flexible, faster and safer solutions for several electrical operations at a highly competitive cost.

## Range codification:

### Standard products

They are listed in this section and are encoded according to the 16-digit bar logic explained below. This descriptive method will be used on all pages in the cam switches range for your convenience and better understanding.

### Special products

They are made according to customer specifications or to comply with a diagram or special scheme. In these cases, the code is formed by the corresponding series (T-TB-TF-TP), the amperage and an order number assigned to the scheme (see blank diagrams form).

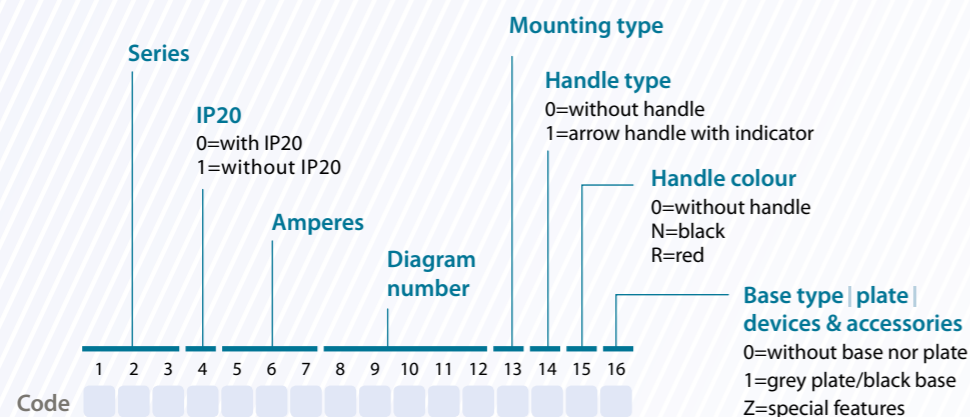

Example **T-0010000012E1N1**  
T series | 100 amperes | 012 diagram | E fixing | Standard handle | Black colour | Grey plate/black base |

### series T



Wide range of sizes and ratings.  
Supplied with IP20 removable terminals protection on sizes 0 - 1 - 2 (except T175).  
Wide range of devices and accessories.

### series TB



Side access to all terminal screws (up and down).  
Two different bodies depending on mounting type: door or base mounting.  
Wide range of devices and accessories.

### series TF



Square body, smooth sides, axial access to terminal screws.  
Two different bodies depending on mounting type: door or base mounting.  
Wide range of devices and accessories.

### series TP



Reduce-sized body. Door mounting only.  
Wide range of devices and accessories.

### series | type TIP



- > Cam switch in plastic enclosure for gland entry.
- > From 12 up to 40 A.
- > Padlockable handle under request.

### series | type T-TFIR



- > Cam switch in plastic enclosure for gland entry.
- > From 25 up to 100 A.
- > Padlockable handle under request.

### series | type T-TBIA-C



- > Cam switch in metal enclosure of cast aluminium
  - A From 12 up to 63 A.
- > In sheet steel enclosure
  - C From 100 A upwards.
- > Gland entry.
- > Several enclosure sizes.
- > Padlockable handle under request.

>> Ask for more information about these applications with enclosure.

# TP | T | TB | TF

## Door mounting

### Fixing with screws | E type

For T - TB - TF - TP series

- > Frontal fixing plate for 4 screws, reversible mounting plate in T series (except T175 and size 3).
- > Door mounting with arrow handle, indicating plate, escutcheon and fixing plate IP65.

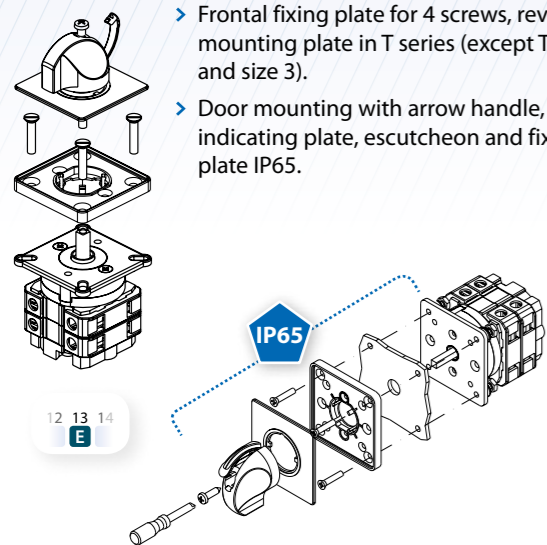

### Central quick fixing $\varnothing 22$ | C type

For T - TB - TF series

- > Door mounting for  $\varnothing 22$  mm available for sizes 0 and 1.
- > For arrow handle with indicator or padlockable handle.
- > Maximum number of chambers supported  
Size 0 = 6  
Size 1 = 4

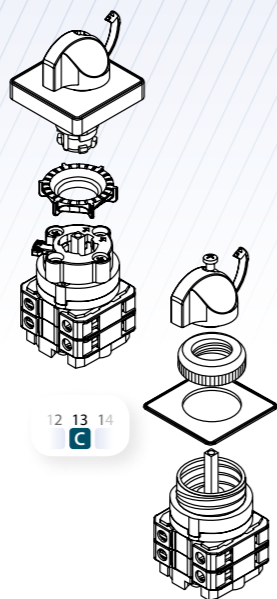

### Central fixing with metal nut $\varnothing 22$ | Z type

For T - TF series

- > Door mounting for metal nut  $\varnothing 22$  mm available for sizes 0 and 1.  
(also  $\varnothing 30$  mm under request).

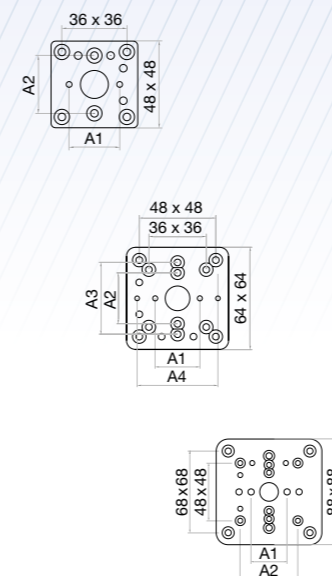
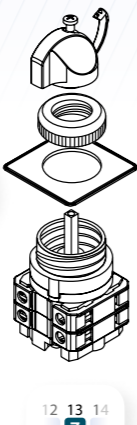

Size	Models		13
0	A1 = 28 mm	A2 = 32 mm	M
	A1 = 30 mm	A2 = 34 mm	N
	A1 = 35 mm	A2 = 38 mm	O
1	A1 = 28 mm A4 = 46 mm	A2 = 32 mm	M
	A1 = 33 mm A3 = 47 mm	A2 = 30 mm A4 = 50 mm	N
	A1 = 32 mm A3 = 45 mm	A2 = 32 mm A4 = 45 mm	P
2	A1 = 38 mm	A3 = 40 mm	M
	A1 = 30 mm	A2 = 50 mm	P

### Multi-distance fixing plates with screws

For T - TB - TF series

- > Multidrill plates for different fixing distances.
- > Fixing with two screws for mounting without base nor indicating plate.
- > Available for sizes 0 - 1 - 2.  
(size 0 also supports multi-fixing plate size 1).

## Base mounting

### Base mounting by screws with direct handle | D type

### Base mounting by screws without plate and handle | G type

For T series

- > Rear fixing plate for 4 screws, reversible mounting plate in T serie (except T175 and size 3).

For TB - TF series

- > Fixed rear support plate as standard.
- > Serie TB for 4 screws.
- > Serie TF for two screws (also DIN rail).

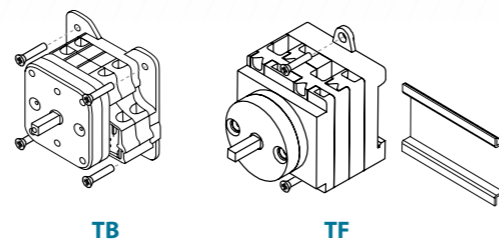
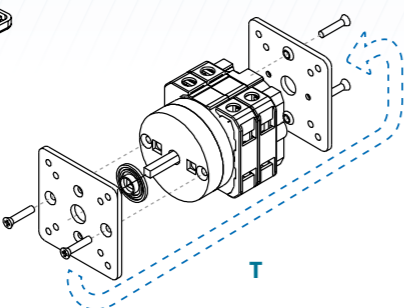
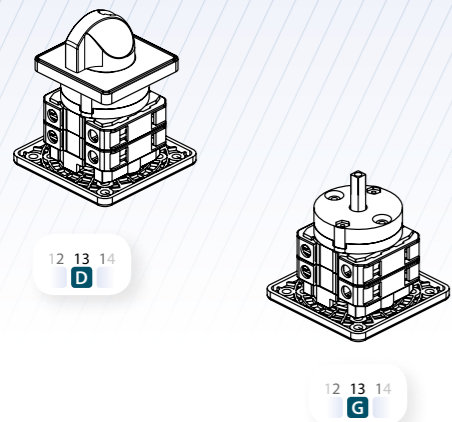

### DIN rail mounting with direct handle | A type

For T series

- > Rear fixing support (D904) for T series sizes 0 and 1.
- > DIN rail is included in TF series.

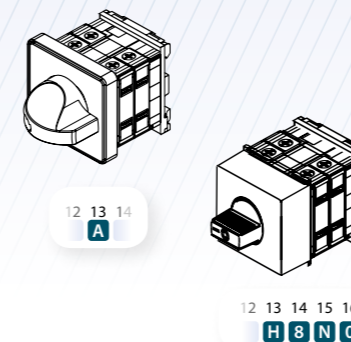

### DIN rail mounting with modular handle | H type

For TF series

- > Rear fixing support and modular handle tape (D905) for T - TF series size 0.

### Base mounting with clutch device and door handle | F type

For T - TB - TF series

- > Rear fixing plate for 4 screws in T - TB series or two screws and DIN rail in TF serie.
- > With clutch device and door lock, according to series and sizes.
- > The clutch device (D501) for size 0, if it is combined with other accessory, must be size 1.
- > The clutch device (D501) and shaft extension are supplied separately (as accessories) or incorporated with the cam switch (size 3 is always incorporated with the cam switch).
- > Specify useful depth of the space available when ordering.

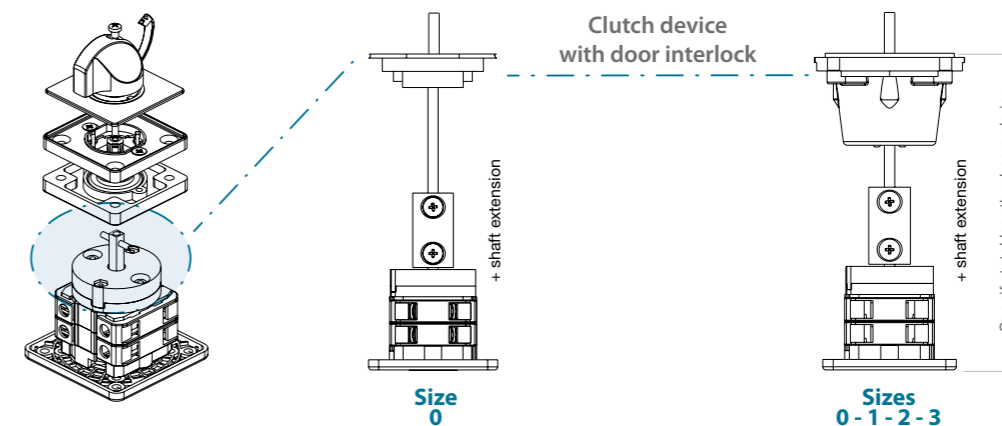
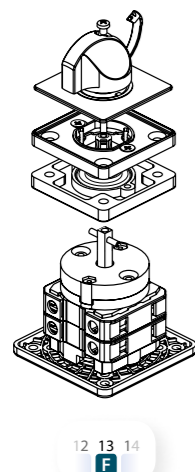



# TP|T|TB|TF Standard diagrams

For many switching operations that can be resolved using cam switches, we have a number of standard schemes applicable to the most common applications in electrical installations, equipment, machinery, etc. If you do not find what you are looking for in this selection, or have a special switching requirement, you can use the blank diagrams form on the next page and send it to our sales department. The descriptive logic representing and interpreting the circuits are explained below.

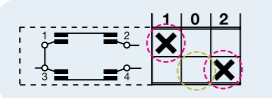

**X** It represents "closed contact".

**□** It represents "opened contact".

The contact 1/2 is closed in position 1 and opened in positions 0 & 2.

The contact 3/4 is closed in position 2 and opened in positions 0 & 1.

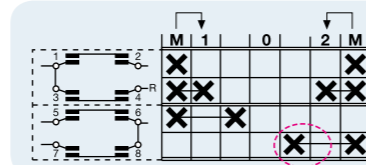

**X** **X** They represent "late break contact" or "early-make contact" in relation to others.

The contacts 5/6 & 7/8 close before the contacts 3/4 & 1/2 and they will also open after these contacts.

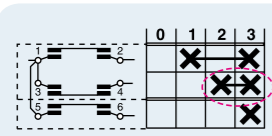

**X** **X** It represents closed contact "without interruption".

The contact 1/2 closes in position 1, and remains closed in position 2 & 3.

The contact 3/4 closes in position 2 and remains closed in position 3.

When passing from one position to another there is no contact interruption in any cases.

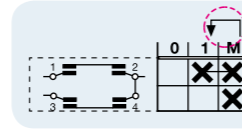

**↶** It represent "spring return" to previous position.

The M position is not fixed and it will return to position 1 when the handle is released.

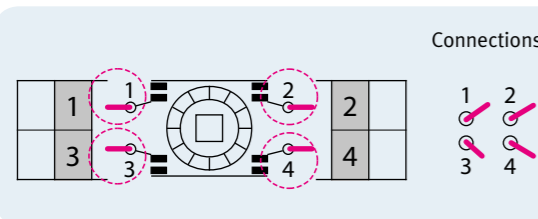

Connection point.

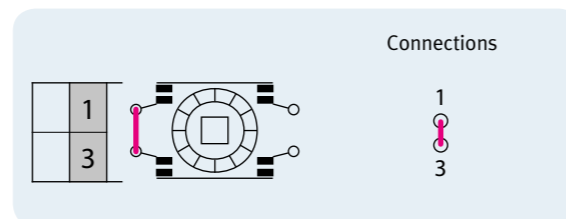

Vertical bridging link.

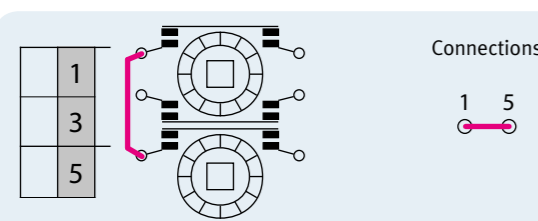

Horizontal bridging link.

Inscription plate Name plate

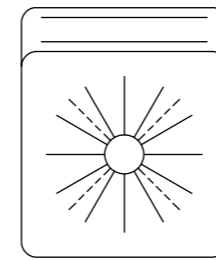

## ORDER SHEET FOR NON-STANDARD CAM SWITCHES 10 TO 315 AMP.



Series

Code

- Contact closed **X**
- Closed contact without interruption **X****X**
- Late break contact **X****↶**
- Early-make contact **↶****X**
- Return from 30° **↶**

Rev.

Number of switch positions

1		2	
3		4	
5		6	
7		8	
9		10	
11		12	
13		14	
15		16	
17		18	
19		20	
21		22	
23		24	
25		26	
27		28	
29		30	
31		32	
33		34	
35		36	
37		38	
39		40	
41		42	
43		44	
45		46	
47		48	

Connections

1	5	9	13	17	21	25	29	33	37	41	45
0	0	0	0	0	0	0	0	0	0	0	0
3	7	11	15	19	23	27	31	35	39	43	47
46	42	38	34	30	26	22	18	14	10	6	2
0	0	0	0	0	0	0	0	0	0	0	0
48	44	40	36	32	28	24	20	16	12	8	4

T series

0	12	20			
1	16	25	32	40	
2	50	63	80	100	125
3	200	250	315		

TB series

20	25	32	40
----	----	----	----

TF series

12	16	25	32	40
----	----	----	----	----

TP series

10
----

Type

E	C	Z	D	G	H	F
---	---	---	---	---	---	---

Handle

Indicator arrow	Black	Shaft extension mm
Ball lever handle	Red	
Double handle	Yellow	
Key	Yellow	

Nameplate

Aluminium colour	Normal
Yellow colour	With inscription
Switching angle 30° -45° -60° -90°	

Materials

\_\_\_\_\_

\_\_\_\_\_

\_\_\_\_\_

\_\_\_\_\_

\_\_\_\_\_

\_\_\_\_\_

\_\_\_\_\_

\_\_\_\_\_

\_\_\_\_\_

\_\_\_\_\_

\_\_\_\_\_

\_\_\_\_\_

\_\_\_\_\_

\_\_\_\_\_

\_\_\_\_\_

Chambers

Notes

Validity

Date

Signature

Special devices

\_\_\_\_\_

\_\_\_\_\_

\_\_\_\_\_

\_\_\_\_\_

On-Off switches

<b>010</b> 1 pole 1 chamber	<b>010/5</b> 5 poles <b>010/6</b> 6 poles <b>010/7</b> 7 poles <b>010/8</b> 8 poles <b>010/9</b> 9 poles	<b>011</b> 2 poles 1 chamber	<b>010/10</b> 10 poles <b>010/11</b> 11 poles <b>010/12</b> 12 poles <b>010/13</b> 13 poles <b>010/14</b> 14 poles	<b>012</b> 3 poles 2 chambers	<b>010/15</b> 15 poles <b>010/16</b> 16 poles <b>010/17</b> 17 poles <b>010/18</b> 18 poles <b>010/19</b> 19 poles	<b>013</b> 4 poles 2 chambers	<b>010/20</b> 20 poles <b>010/21</b> 21 poles <b>010/22</b> 22 poles <b>010/23</b> 23 poles <b>010/24</b> 24 poles
-----------------------------------	--	------------------------------------	--	-------------------------------------	--	-------------------------------------	--

To view these wiring diagrams please visit our download area on [www.telergon.com](http://www.telergon.com)

On-Off switches with contacts leading when making

<b>020</b> 3 poles 1 preclosed pole 2 chambers	<b>021</b> 4 poles 1 preclosed pole 2 chambers	<b>022</b> 4 poles 3 preclosed poles 2 chambers
--	--	---

Reversing switches

<b>101</b> 2 poles 2 chambers
-------------------------------------

Reversing switches

<b>102</b> 3 poles 3 chambers
-------------------------------------

Reversing switches with spring return

<b>111</b> 2 poles 2 chambers	<b>112</b> 3 poles 2 chambers	<b>113</b> 3 poles for use with reserving contactors 4 chambers
-------------------------------------	-------------------------------------	--

Control switches with spring return

<b>201</b> Start switch 1 pole 1 chamber	<b>202</b> Stop switch 1 pole 1 chamber	<b>203</b> Start switch 2 poles 1 chamber	<b>204</b> Stop switch 2 poles 1 chamber
--	---	---	--

Stop-Start switches

<b>205</b> With contactor 1 chamber	<b>206</b> With contactor and spring return 1 chamber	<b>207</b> With spring return to run for 2 units 2 chambers
---	---	---

Start delta switches

<b>300</b> Normal type 4 chambers	<b>301</b> Auxiliary contact closed in "0" 5 chambers	<b>302</b> Reversing 5 chambers	<b>303</b> Rotary 0-λ-Δ-0-λ-Δ-0 5 chambers	<b>304</b> Position λ return to 0 0-λ-Δ 4 chambers	<b>305</b> Reversing. Return from λ to 0 Δ-λ-0-λ-Δ 5 chambers	<b>308</b> Use with contactor 0-λ-Δ 4 chambers	<b>309</b> Reversing for use with contactor Δ-λ-0-λ-Δ 7 chambers
---	---	---------------------------------------	---	---	--	---	---

To view these wiring diagrams please visit our download area on [www.telergon.com](http://www.telergon.com)

Start delta switches

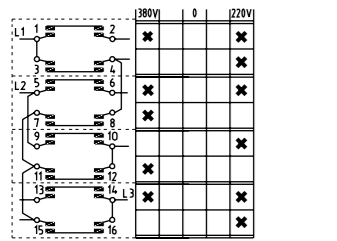
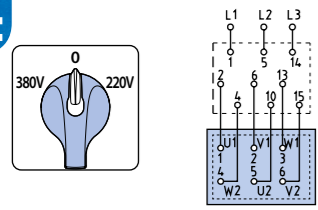

**310**  
Selector  $\lambda - \Delta$   
380 - 0 - 220  
4 chambers

Split phase starting switches

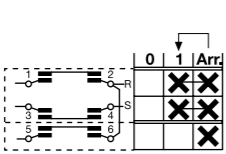
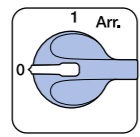

**315**  
Start return to 1  
2 chambers

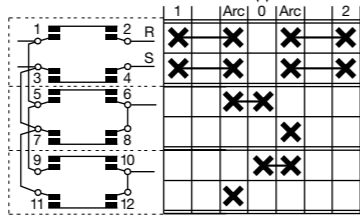
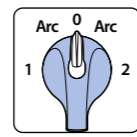

**316**  
Reversing type of T315  
1 - ARR - 0 - ARR - 2  
3 chambers

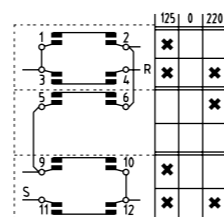
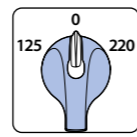

**317**  
Start single phase 2 voltages  
3 chambers

Dahlander multi-step switches

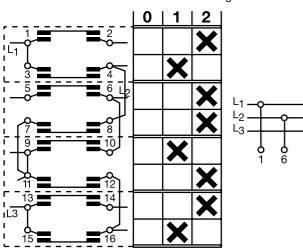
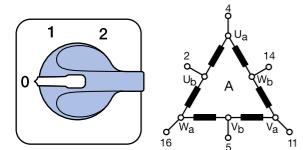

**330**  
Dahlander  $0 - \Delta_A - \lambda \lambda_A$   
4 chambers

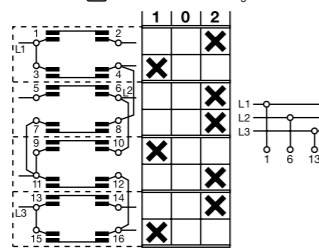
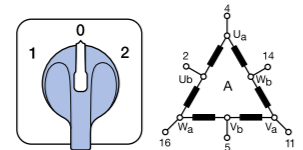

**331**  
Dahlander  $\Delta_A - 0 - \lambda \lambda_A$   
4 chambers

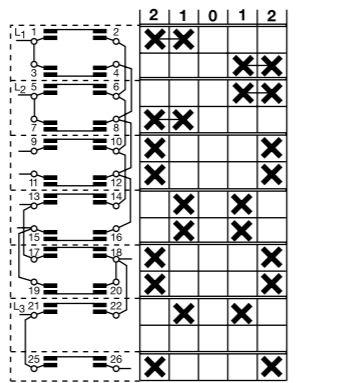
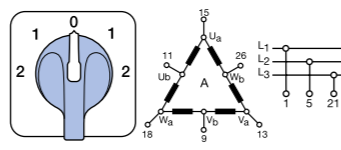

**332**  
Reversing type of T330  
7 chambers

**333**  
Dahlander  $0 - \Delta_A - \lambda \lambda_A - 0 - \Delta_A - \lambda \lambda_A - 0$   
0 - 1 - 2 - 0 - 1 - 2  
5 chambers  
**334**  
For use with contactor  
0 - 1 - 2  
5 chambers  
**335**  
Selector Dahlander  
 $0 - \lambda - \Delta_A - \lambda \lambda_A$   
6 chambers  
**336**  
Reversing Dahlander  
 $\lambda \lambda_A - \Delta_A - \lambda - 0 - \lambda - \Delta_A - \lambda \lambda_A$   
2 - 1 -  $\lambda - 0 - \lambda - 1 - 2$   
8 chambers

To view these wiring diagrams please visit our download area on [www.telergon.com](http://www.telergon.com)

Separate winding to speed

**340**  
 $0 - \lambda_A - \Delta - \lambda_B$   
 $0 - \lambda - 1 - 2$   
6 chambers  
**341**  
 $0 - \Delta_A - \lambda_B$   
 $0 - 1 - 2$   
4 chambers

**342**  
 $0 - A - B$  en  $\lambda$  or  $\Delta$   
 $0 - 1 - 2$   
3 chambers  
**343**  
Reversing del 342  
 $2 - 1 - 0 - 1 - 2$   
5 chambers

**344**  
 $\Delta_B - \lambda_B - 0 - \lambda_A - \Delta_A$   
 $1 - \lambda - 0 - \lambda - 2$   
8 chambers  
**350**  
 $0 - \lambda_A - \Delta_B - \lambda \lambda_B$   
 $0 - 1 - 2 - 3$   
6 chambers

**351**  
Reversing type of T350  
 $3 - 2 - 1 - 0 - 1 - 2 - 3$   
9 chambers

To view these wiring diagrams please visit our download area on [www.telergon.com](http://www.telergon.com)

Changeover switches with center "Off"

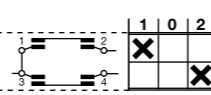
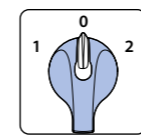

**400**  
1 pole  
1 chamber

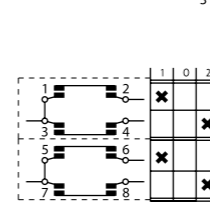
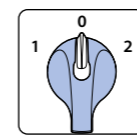

**401**  
2 poles  
2 chambers

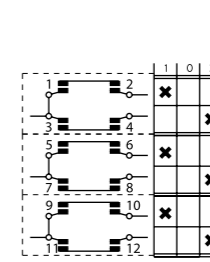
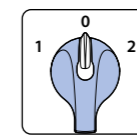

**402**  
3 poles  
3 chambers

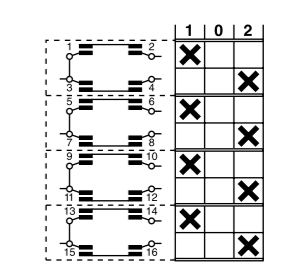
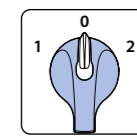

**403**  
4 poles  
4 chambers

	Poles	Positions	Chambers		Poles	Positions	Chambers		Poles	Positions	Chambers		Poles	Positions	Chambers				
400/5	5	3	5	00400	400/7	7	3	7	00401	400/9	9	3	9	00402	400/11	11	3	11	00403
400/6	6	3	6	00310	400/8	8	3	8	00402	400/10	10	3	10	00402	400/12	12	3	12	00403

To view these wiring diagrams please visit our download area on [www.telergon.com](http://www.telergon.com)

Changeover switches with spring return to center

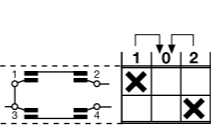
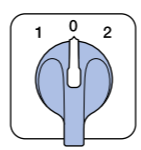

**405**  
1 pole  
1 chamber

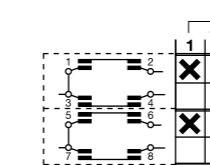
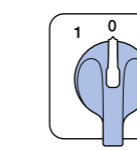

**406**  
2 poles  
2 chambers

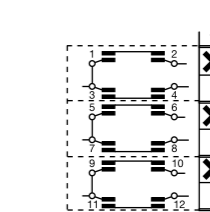
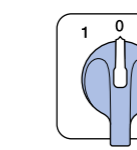

**407**  
3 poles  
3 chambers

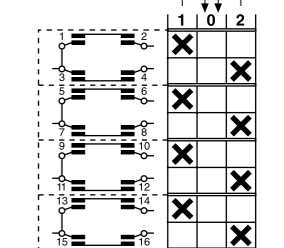
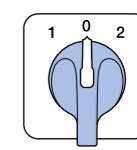

**408**  
4 poles  
4 chambers

Multi-step switches with "Off" position

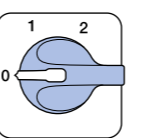

**410**  
1 pole 2 positions  
1 chamber

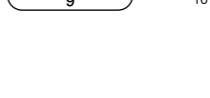
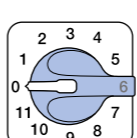

**419**  
1 pole 11 positions  
6 chambers

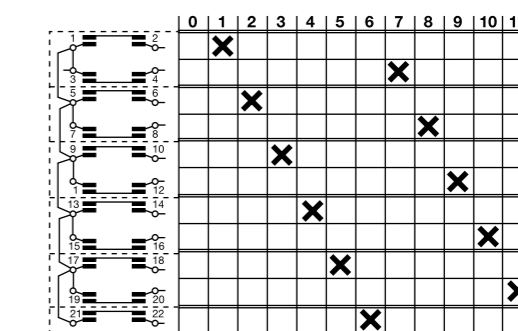



Multi-step switches with "Off" position

	Poles	Positions	Chambers		Poles	Positions	Chambers		Poles	Positions	Chambers		Poles	Positions	Chambers
411	1	3	2	422	2	4	4	432	3	4	6	452	5	4	10
412	1	4	2	423	2	5	5	433	3	5	9	460	6	2	6
413	1	5	3	424	2	6	7	434	3	6	12	461	6	3	9
414	1	6	4	425	2	7	8	435	3	7	12	462	6	4	12
415	1	7	4	426	2	8	9	440	4	2	4	470	7	2	7
416	1	8	5	427	2	9	10	441	4	3	6	471	7	3	11
417	1	9	5	428	2	10	11	442	4	4	8	480	8	2	8
418	1	10	6	429	2	11	12	443	4	5	10	481	8	3	12
420	2	2	2	430	3	2	3	450	5	2	5	490	9	2	9
421	2	3	3	431	3	3	5	451	5	3	8				

To view these wiring diagrams please visit our download area on [www.telergon.com](http://www.telergon.com)

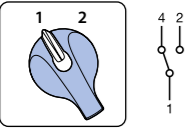
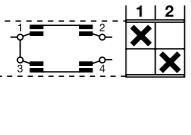

Changeover switches without "Off"

**500**  
1 pole  
1 chamber

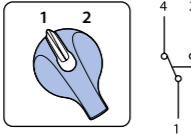
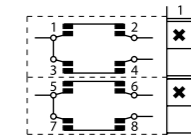
**501**  
2 poles  
2 chambers

**502**  
3 poles  
3 chambers

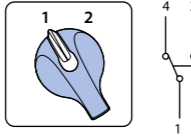

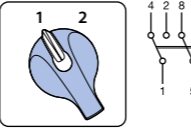
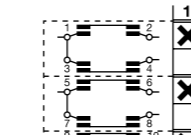

**503**  
4 poles  
4 chambers

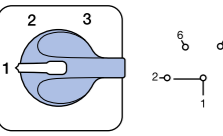
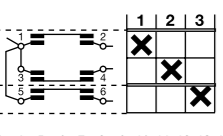

Poles	Positions	Chambers	Poles	Positions	Chambers	Poles	Positions	Chambers	Poles	Positions	Chambers				
500/5	5	2	5	500/7	7	2	7	500/9	9	2	9	500/11	11	2	11
500/6	6	2	6	500/8	8	2	8	500/10	10	2	10	500/12	12	2	12

To view these wiring diagrams please visit our download area on [www.telergon.com](http://www.telergon.com)

Multi-step switches without "Off" position

**510**  
1 pole 3 positions  
2 chambers

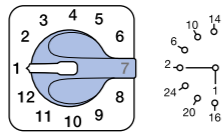
**519**  
1 pole 12 positions  
6 chambers

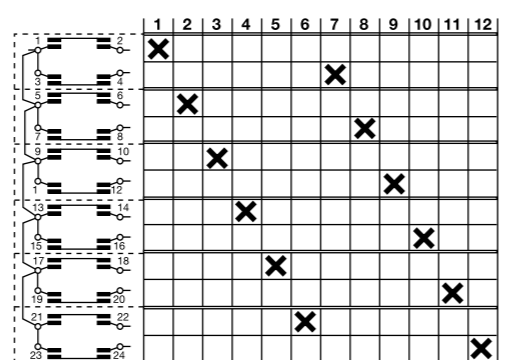

Multi-step switches without "Off" position

	Poles	Positions	Chambers		Poles	Positions	Chambers		Poles	Positions	Chambers		Poles	Positions	Chambers
511	1	4	2	521	2	4	4	530	3	3	5	543	4	6	12
512	1	5	3	522	2	5	5	531	3	4	6	550	5	3	8
513	1	6	3	523	2	6	6	532	3	5	8	551	5	4	10
514	1	7	4	524	2	7	7	533	3	6	9	552	5	5	13
515	1	8	4	525	2	8	8	534	3	7	11	560	6	3	9
516	1	9	5	526	2	9	9	535	3	8	12	561	6	4	12
517	1	10	5	527	2	10	10	540	4	3	6	570	7	3	11
518	1	11	6	528	2	11	11	541	4	4	8	580	8	3	12
520	2	3	3	529	2	12	12	542	4	5	10				

To view these wiring diagrams please visit our download area on [www.telergon.com](http://www.telergon.com)

Gang switches

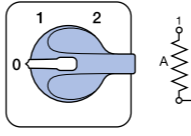
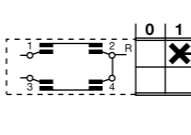
**601**  
1 pole switching sequence  
0 - A - (A+B)  
1 chamber

**602**  
2 poles switching sequence  
0 - A - B  
2 chambers

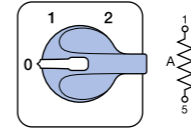
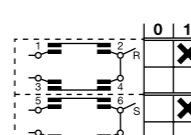

**603**  
1 pole switching sequence  
0 - A - B - (A+B)  
1 chamber

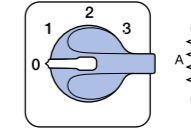
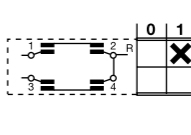
**604**  
2 poles switching sequence  
0 - A - B - (A+B)  
2 chambers

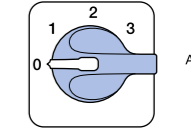
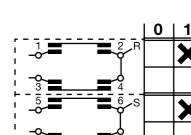
**605**  
1 pole switching sequence  
0 - A - (A+B) - (A+B+C)  
2 chambers

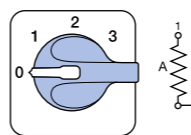
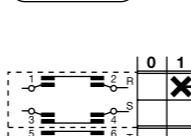
**606**  
2 poles switching sequence  
0 - A - (A+B) - (A+B+C)  
3 chambers

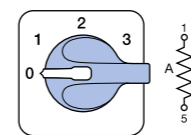
**607**  
3 poles switching sequence  
0 - A - (A+B)  
3 chambers

**608**  
3 poles switching sequence  
0 - A - B - (A + B)  
3 chambers

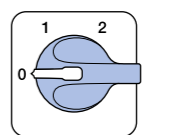
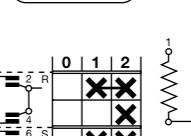
Gang switches

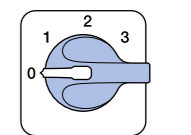
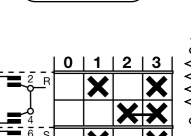
**609**  
3 poles switching sequence  
0 - A - (A+B) - (A+B+C)  
5 chambers

**610**  
Switching sequence  
λ 0 - A - (A+B) - (A+B+C)  
2 chambers

**611**  
Switching sequence  
Δ 0 - A - (A+B) - (A+B+C)  
2 chambers

**612**  
Switching sequence 0 - A + B series  
A - B - (A + B) paralell  
2 chambers

**626**  
3 phases, 6 points  
5 chambers

**630**  
Switching sequence  
0 - A - (A+B) - (A+B+C)  
2 chambers

**631**  
Switching sequence  
0 - A - (A+B) - (A+B+C) - (A+B+C+D)  
2 chambers

**632**  
Switching sequence  
0 - A - (A+B) - (A+B+C) - (A+B+C+D) - (A+B+C+D+E)  
3 chambers

Kitchen and heating switches

**613**  
3 positions switching sequence  
0-A+B paralell; A or B-A+B series -0  
3 chambers

**614**  
3 positions switching sequence  
0-A+B series; A or B-A+B paralell  
2 chambers

Resistance elimination switches

**620**  
3 phases, 3 points  
2 chambers

**621**  
3 phases, 3 points  
3 chambers  
With auxiliary contact

**622**  
3 phases, 4 points  
3 chambers

**624**  
3 phases, 5 points  
4 chambers

Voltmeter switches

**700**  
2 phases C.A. or 2 poles C.C.  
2 chambers

**701**  
3 phases  
2 chambers

**702**  
3 phases to neutral  
2 chambers

**704**  
3 phases and 1 phase to neutral  
3 chambers

**703**  
4 lines with 2 wires C.A. o C.C.  
4 chambers

**705**  
3 phases to phase and 3 phases to neutral  
3 chambers

**706**  
2 three-phase lines (phase to phase)  
4 chambers/chambers

To view these wiring diagrams please visit our download area on [www.telergon.com](http://www.telergon.com)



Ammeter switches

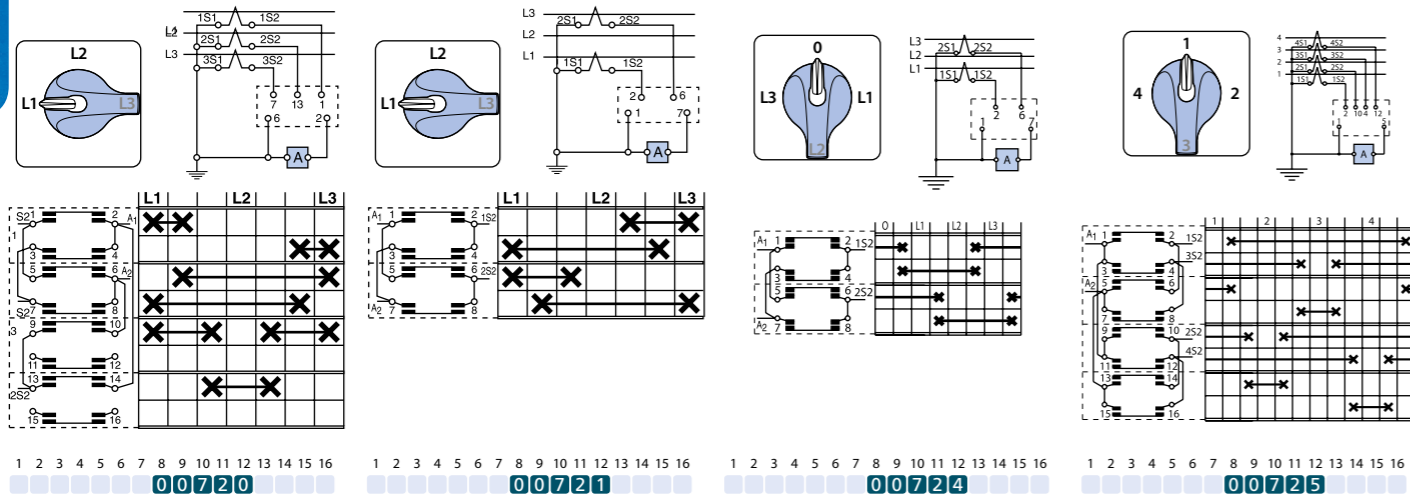

00720, 00721, 00724, 00725

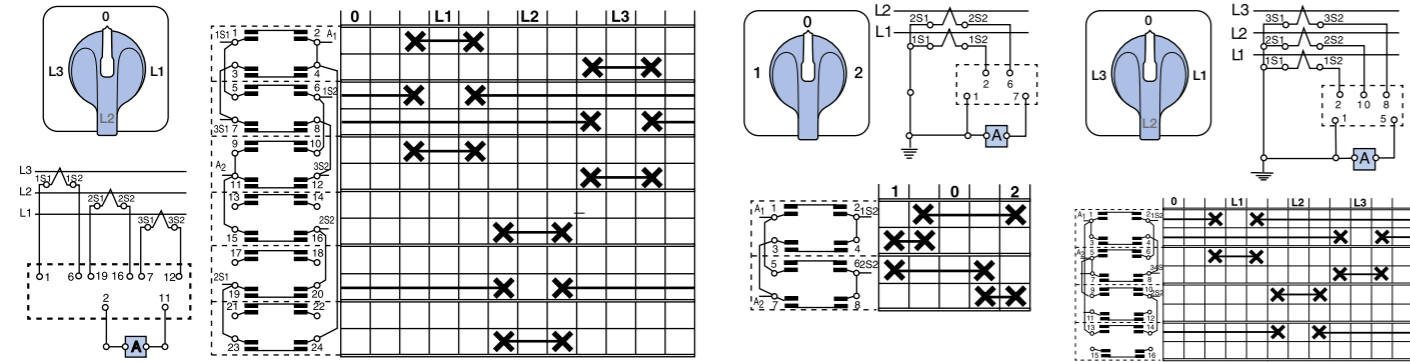

00727, 00730, 00731

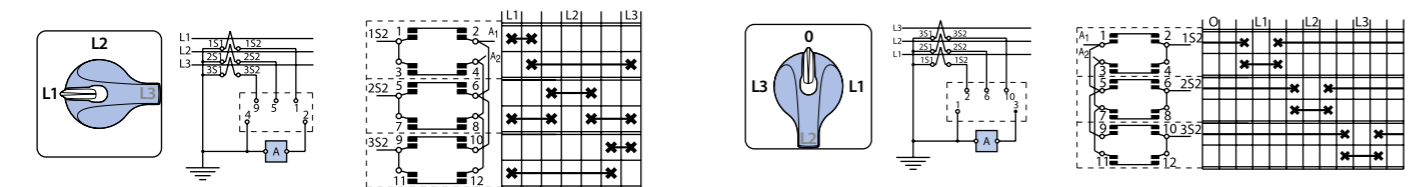

00732, 00733

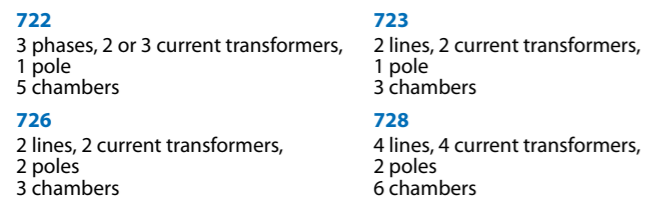

To view these wiring diagrams please visit our download area on [www.telergon.com](http://www.telergon.com)

Switches for B.C.D. codification with "Off"

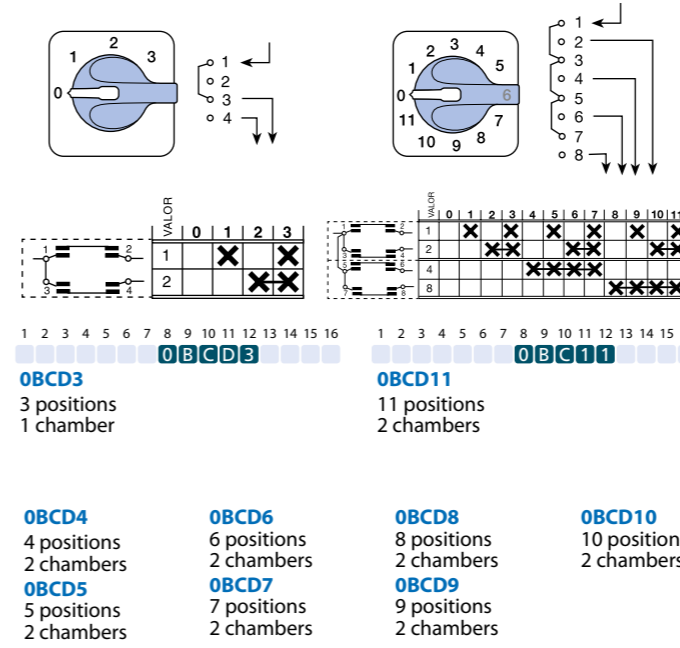

To view these wiring diagrams please visit our download area on [www.telergon.com](http://www.telergon.com)

By-pass switches

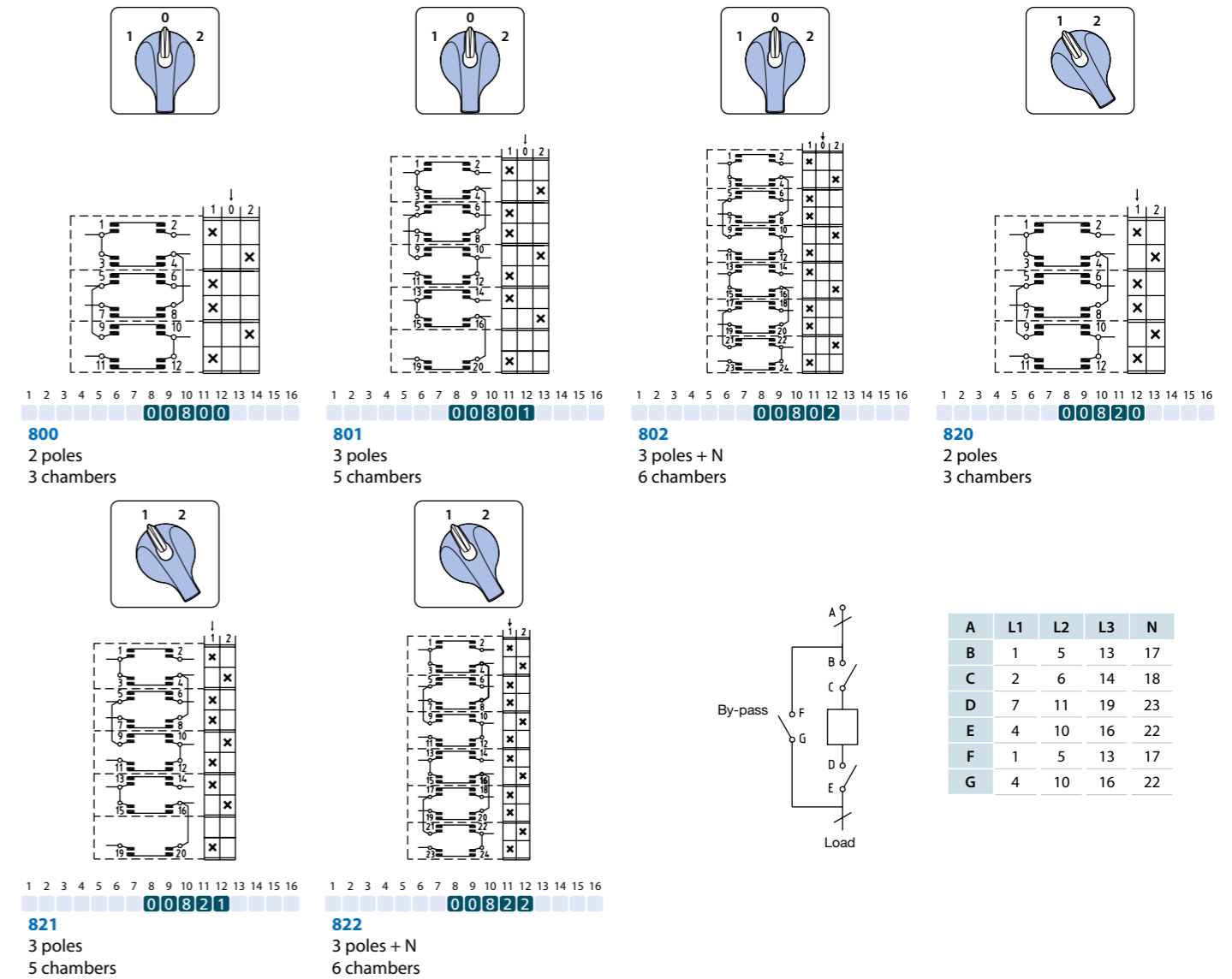

# T Door mounting

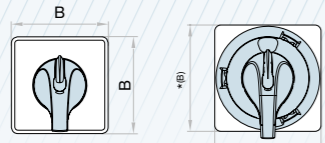

Door mounting drilling

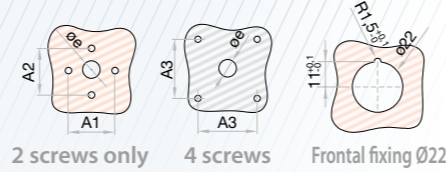

Note:  
The cam switches allow a construction up to 12 chambers (24 contacts).  
It's necessary to distribute in several columns (maximum three of 12 chambers each) when the number of contacts is higher than 24, so we use the tandem drives D200 or D201.  
Depending on the number of contacts to be switched simultaneously, it's possible to supply up to 14 chambers switches in size 0.

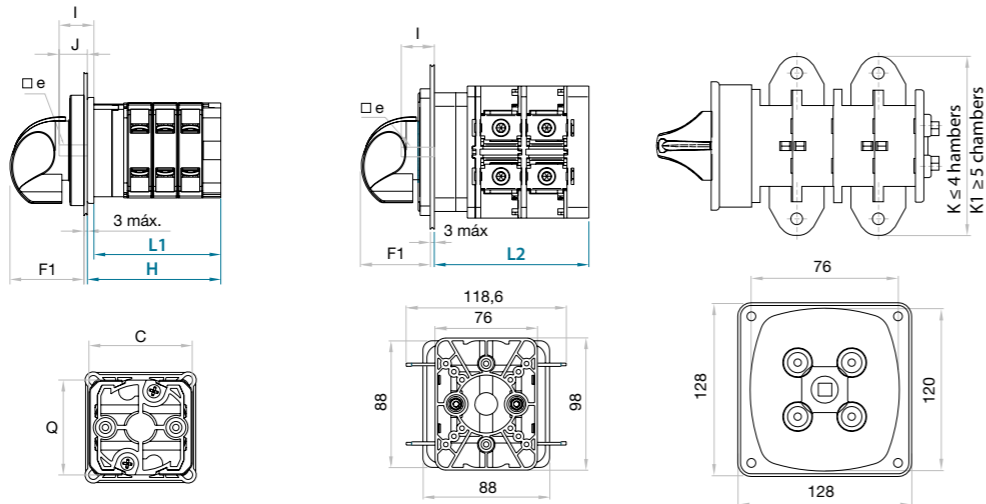

Size	Series	A1	øA1	A2	øA2	A3	øA3	B	C	øe	□e	Q	F1	I	J	K	K1
0	T12 T20	32	4,5	-	4,5	36	4,5	50	46,5	12	5	46	33,5	18	15	-	-
1	T16 T25 T32 T40	45	4,5	-	4,5	48	4,5	65	60,5	12	5	57,5 64,5	36	20	16,8	-	-
2	T50 T63 T80 T100 T125 T175	-	-	60	5,5	68	5,5	94	66 84,5	12	7	80 89	45	24,5	20,5	-	-
3	T200 T250 T315 T400 T500 T630 T800	-	-	-	-	108	6,5	128	76	16	10	120	67	-	40	150 176 218	-

Size	Series	Chambers														
		1□	2□	3□	4□	5□	6□	7□	8□	9□	10□	11□	12□	13□	14□	
0	T12 T20	L1	34,5	46	57,5	69	80,5	92	103,5	115	126,5	138	149,5	161	172,5	184
		H	37,5	49	60,5	72	83,5	95	106,5	118	129,5	141	152,5	164	175,5	187
1	T16 T25 T32 T40	L1	46,4	60,6	74,8	89	103,2	117,4	131,6	145,8	160	174,2	188,4	202,6	*(1)	*(1)
		H	49,6	63,8	78	92,2	106,4	120,6	134,8	149	163,2	177,4	191,6	205,8	*(1)	*(1)
2	T50 T63 T80 T100 T125 T175	L1	49,8	67,3	84,8	102,3	119,8	137,3	154,8	172,3	189,8	207,3	224,8	242,3	*(1)	*(1)
		H	53	70,5	88	105,5	123	140,5	158	175,5	193	210,5	228	245,5	*(1)	*(1)
3	T200 T250 T315 T400 T500 T630 T800	L1	58,5	78,5	98,5	118,5	138,5	158,5	178,5	198,5	218,5	238,5	258,5	278,5	*(1)	*(1)
		H	62,5	82,5	102,5	122,5	142,5	162,5	182,5	202,5	222,5	242,5	262,5	282,5	*(1)	*(1)
3	T200 T250 T315 T400 T500 T630 T800	L2	67	94	121	147,5	174	201	227,5	254	281	307,5	334	361	*(1)	*(1)
		H	71	98	125	151,5	178	205	231,5	258	285	311,5	338	365	*(1)	*(1)
3	T200 T250 T315 T400 T500 T630 T800	L2	80,8	114,8	148,8	182,8	216,8	250,8	284,8	318,8	352,8	386,8	420,8	454,8	*(1)	*(1)
		H	95	135	175	215	255	295	335	375	415	455	495	535	*(1)	*(1)
3	T400 T500 T630 T800	L	135	215	295	375	455	535	*(1)	*(1)	*(1)	*(1)	*(1)	*(1)	*(1)	*(1)
		H	175	295	415	535	*(1)	*(1)	*(1)	*(1)	*(1)	*(1)	*(1)	*(1)	*(1)	*(1)

\*(1) Tandem drive D200/D201

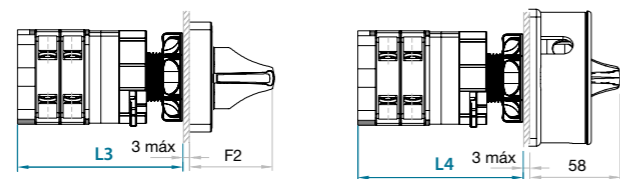

Size	Series	Chambers *(ch)							
		1□	2□	3□	4□	5□	6□	F2	
0	T12 T20	L3	63,5	75	86,5	98	109,5	121	53,5
1	T16 T25 T32 T40	L4	75,5	89,5	103,8	118	-	-	55,5
		H	78,8	96,3	116,8	131,3	-	-	55,5

\*(ch) Central quick fixing ø22 - maximum number of chambers supported.

# TB Door mounting

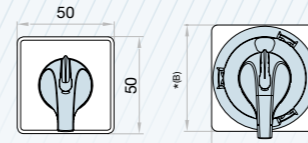

Door mounting drilling

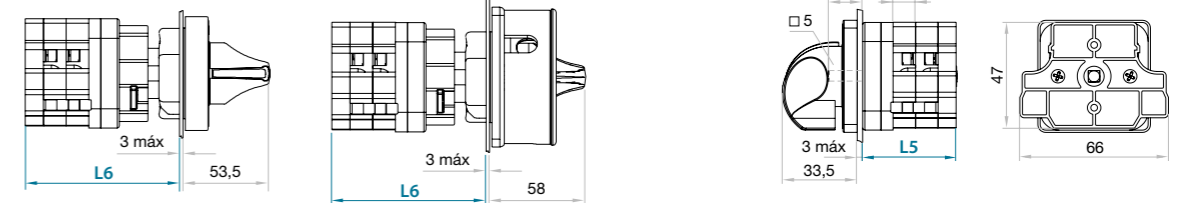
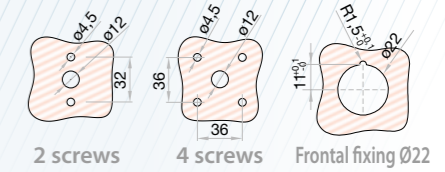

L5	Chambers											
	1□	2□	3□	4□	5□	6□	7□	8□	9□	10□	11□	12□
L6	31,5	41,5	51,5	61,5	71,5	81,5	91,5	101,5	111,5	121,5	131,5	141,5

# TF Door mounting

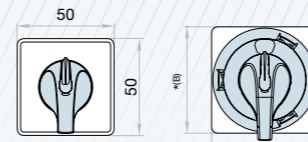

Door mounting drilling

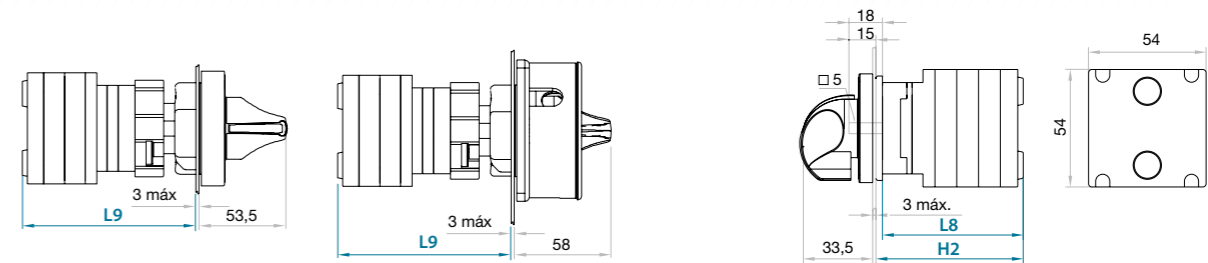
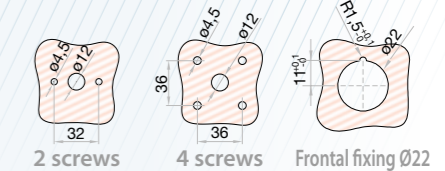

L8	Chambers											
	1□	2□	3□	4□	5□	6□	7□	8□	9□	10□	11□	12□
L9	45	55	65	75	85	95	105	115	125	135	145	155
H2	73,5	83,5	93,5	103,5	113,5	123,5	-	-	-	-	-	-

# TP Door mounting



Door mounting drilling

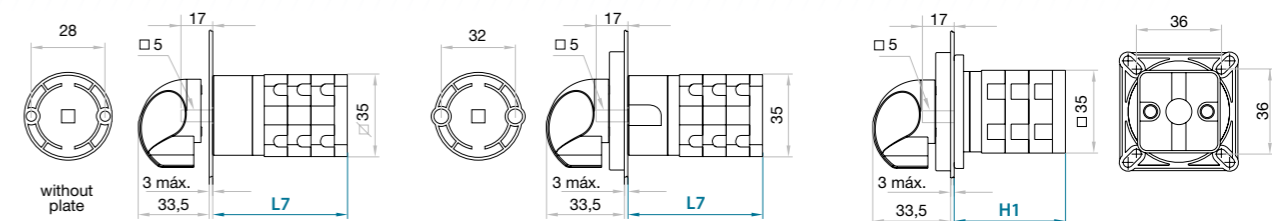
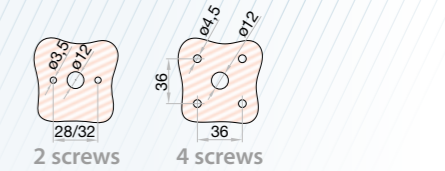

L7	Chambers											
	1□	2□	3□	4□	5□	6□	7□	8□	9□	10□	11□	12□
H1	26,5	36	45,5	55	64,5	74	83,5	93	102,5	112	121,5	131



## T Base mounting with clutch device

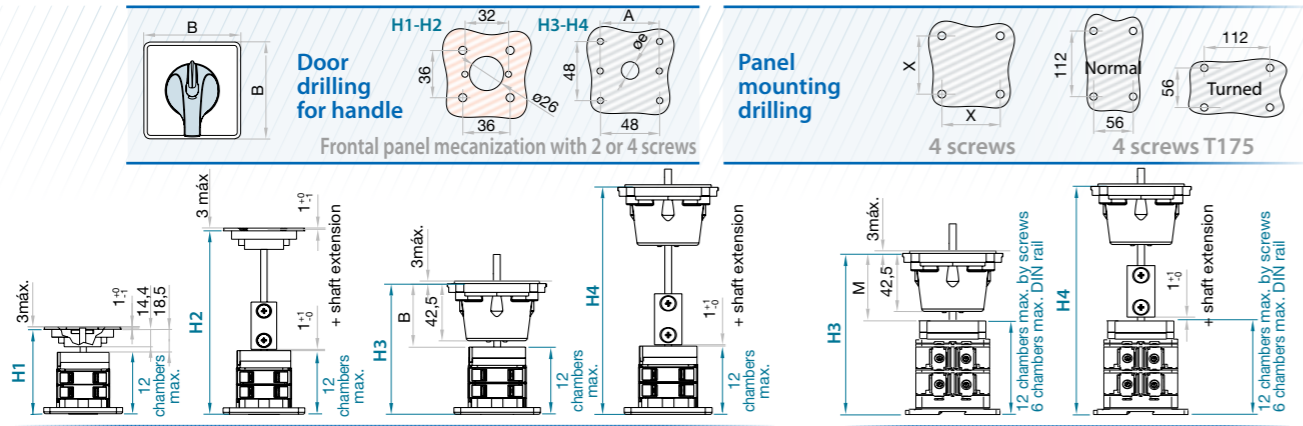

Size	Series	Chambers				A	B	øe	M	X	
		H1	H2	H3	H4						
0	T12 T20	min	56	+11,5	94	+11,5	32	50	12	45,5	36
		max	-	-	256	-	283	-	-	-	-
1	T16 T25	min	-	-	97,1	+14,2	32	65	12	47,5	48
		max	-	-	297,1	-	323	-	-	-	-
2	T32 T40	min	-	-	100,5	+17,5	32	65	12	47,5	48
		max	-	-	300,5	-	323	-	-	-	-
3	T50 T63 T80	min	-	-	114,5	+20	60	94	12	52	68
		max	-	-	314,5	-	323	-	-	-	-
2	T100 T125	min	-	-	123	+27	60	94	12	52	68
		max	-	-	323	-	341,8	-	-	-	-
1	T175	min	-	-	141,8	+34	60	94	12	52	-
		max	-	-	341,8	-	418	-	-	-	-
3	T200	-	-	-	162,5	+40	-	-	16	67,5	108

## T Base mounting with screws or DIN rail (direct handle)

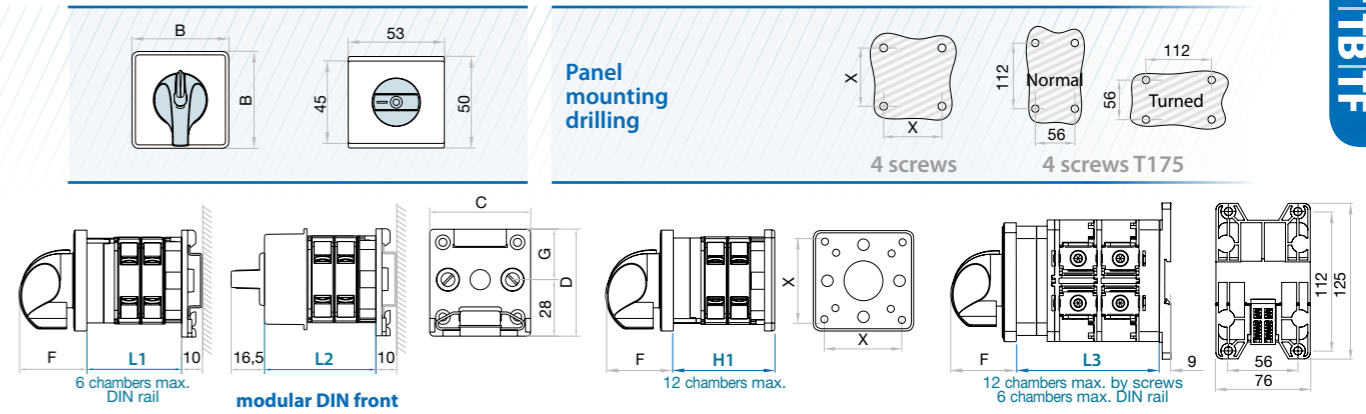

Size	Series	Chambers						B	C	D	F	G	X		
		1	2	3	4	5	6								
0	T12 T20	L1	34,5	46	57,5	69	80,5	92	50	50	53	33,5	25	-	
		L2	-	53,5	65	76,5 <sup>(*)</sup>	-	-	+11,5	-	50	53	-	25	-
		H1	37,5	49	60,5	72	83,5	95	50	-	-	33,5	-	36	-
1	T16 T25	L1	46,4	60,6	74,8	89	-	-	+14,2	65	50	53	36	25	-
		H1	49,6	63,8	78	92,2	106,4	120,6	65	-	-	36	-	48	-
		L1	49,8	67,3	84,8	102,3	-	-	+17,5	65	-	-	36	-	-
2	T32 T40	H1	53	70,5	88	105,5	123	140,5	+17,5	65	-	-	36	-	48
		H1	62,5	82,5	102,5	122,5	142,5	162,5	+20	94	-	-	45,5	-	68
		H1	71	98	125	152	179	206	+27	94	-	-	45,5	-	68
3	T100 T125	L3	80,8	114,8	148,8	-	-	-	+34	94	-	-	45,5	-	-
		H1	95	135	175	215	255	295	+40	132	-	-	67	-	108

<sup>(\*)</sup> Modular enclosure 3 chambers max

## TB Base mounting with clutch device

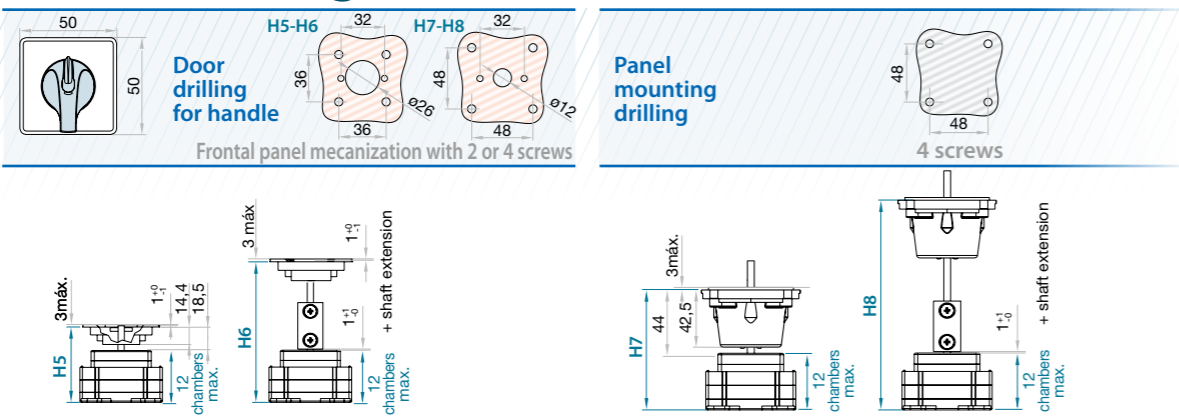

Size	Series	Chambers				H	A	B	X	
		H5	H6	H7	H8					
0	TB20 TB25 TB32	min	46	+10	84	+10	75,5	+10	113	+10
		max	-	-	246	-	275,5	-	275,5	-

## TB Base mounting with screws (direct handle)

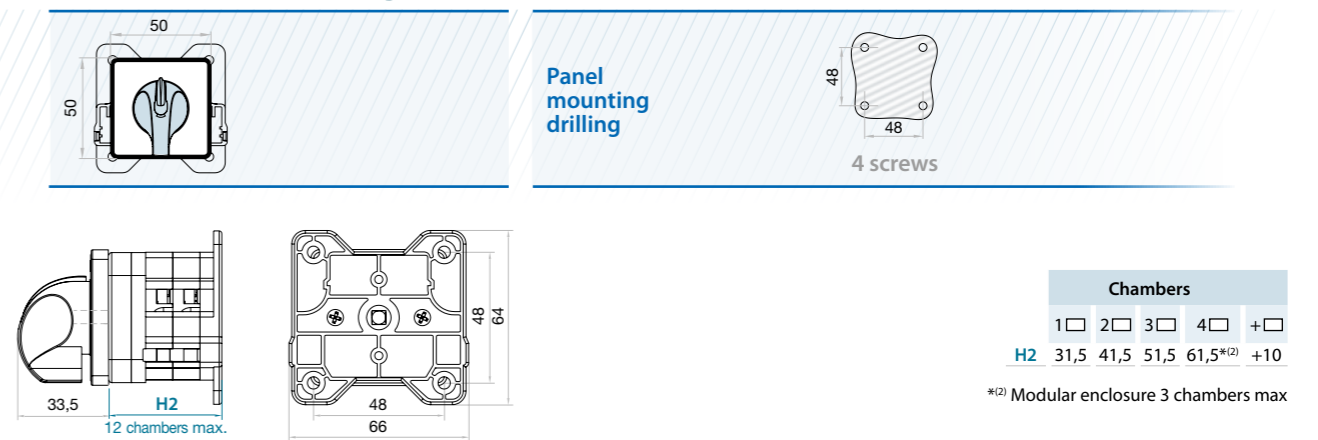

Chambers	
1	2
H2	31,5 41,5 51,5 61,5 <sup>(*)</sup> +10

<sup>(\*)</sup> Modular enclosure 3 chambers max

## TF Base mounting with clutch device

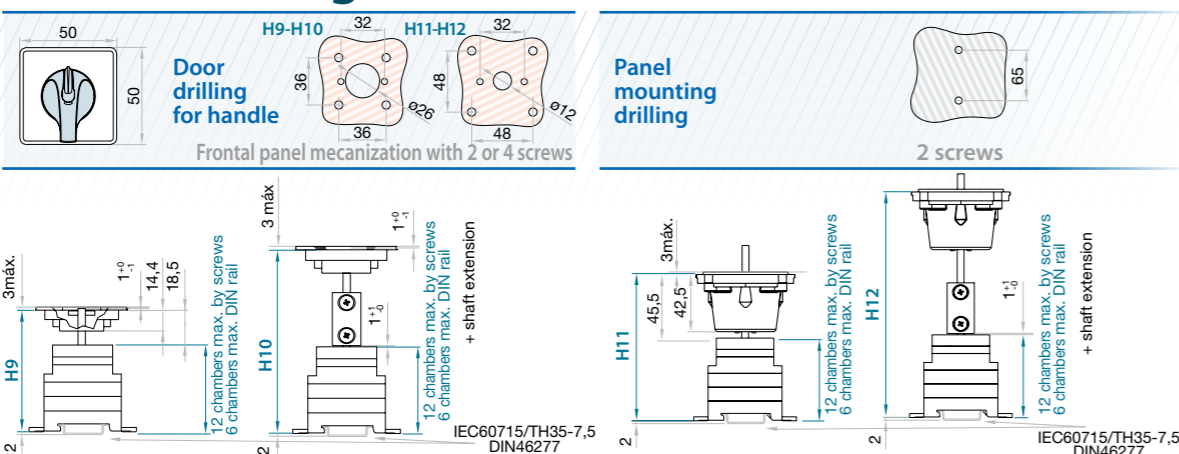

Size	Series	Chambers				H	A	B	X	
		H9	H10	H11	H12					
0	TF12 TF16 TF25	min	65,5	+10	103,5	+10	92,5	+10	130,5	+10
		max	-	-	265,5	-	292,5	-	292,5	-

## TF Base mounting with screws or DIN rail (direct handle)

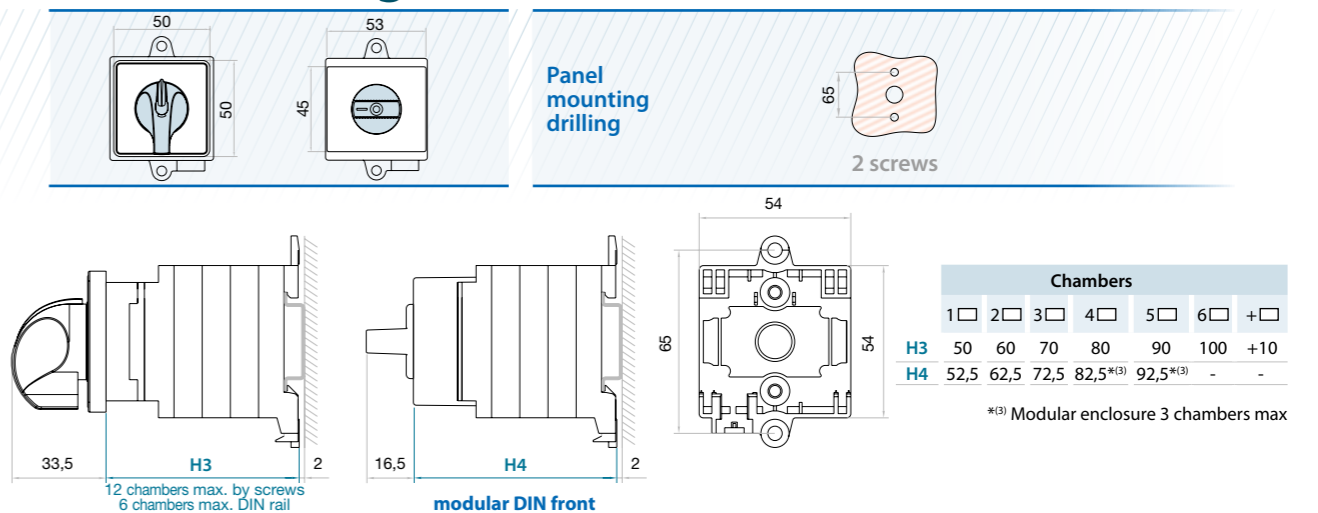

Chambers	
1	2
H3	50 60 70 80 90 100 +10
H4	52,5 62,5 72,5 82,5 <sup>(*)</sup> 92,5 <sup>(*)</sup> -

<sup>(\*)</sup> Modular enclosure 3 chambers max



### Technical specifications

According to IEC 60947-3			Size 0				Size 1				Size 2				Size 3									
			T12	T20	T16	T25	T32	T40	T50	T63	T80	T100	T125	T175	T200	T250	T315	T400	T630	T800	T1250	T1600		
Rated thermal current	Ith	A	16	25	25	32	40	50	63	80	80	125	125	200	200	250	315	400	630	800	1000	1600		
Rated insulation voltage	Ui	V	500	500	690	690	690	690	690	690	690	690	1000	690	690	690	690	690	690	690	690	690		
Rated impulse withstand voltage	Uimp	kV	6	6	6	6	8	8	8	8	8	8	8	8	8	8	8	8	8	8	8	8		
			Ue																					
AC rated operational current	Ie	Ue 415V AC21A	A	16	25	25	32	40	50	63	80	80	125	125	200	200	250	315	315	315	400	500	500	
		Ue 415V AC22A	A	16	20	25	32	40	50	63	80	80	115	115	200	200	250	315	250	315	315	315	400	
AC rated operational power (Rated operational frequency 50/60 Hz)	Pe	3x240V AC23A	kW	4	4	5,5	7,5	11	15	18,5	22	22	30	30	55	55	67	75	55	55	55	55	55	
		3x240V AC3	kW	3	4	5,5	5,5	7,5	11	15	18,5	18,5	30	30	37	45	54	61	45	45	45	45	45	
		3x240V AC4	kW	1,1	1,5	2,2	3	4	4	5,5	7,5	7,5	11	11	15	15	18	20	15	15	15	15	15	
		1x240V AC3	kW	1,5	2,2	3	4	5,5	5,5	7,5	11	11	15	15	18,5	22	22	22	22	22	22	22	22	
		1x240V AC4	kW	0,37	0,55	0,75	1,1	1,5	2,2	3	3	3	4	4	5,5	7,5	9	10	7,5	7,5	7,5	7,5	7,5	
		3x415V AC23A	kW	5,5	7,5	11	11	15	18,5	30	37	37	45	45	90	90	115	130	90	90	90	90	90	90
		3x415V AC3	kW	4	5,5	7,5	7,5	11	15	22	30	30	37	37	75	75	95	108	75	75	75	75	75	75
		3x415V AC4	kW	2,2	3	4	5,5	5,5	7,5	11	11	11	15	15	18,5	22	28	31	22	22	22	22	22	22
		1x400V AC3	kW	2,2	3	4	5,5	7,5	7,5	15	18,5	18,5	18,5	20	37	47	53	37	37	37	37	37	37	37
		1x400V AC4	kW	0,75	1,1	1,5	1,5	2,2	3	4	5,5	5,5	7,5	7,5	11	11	14	16	11	11	11	11	11	11
Rated conditional short-circuit current		kA	10	10	10	10	10	10	15	15	15	15	15	15	15	15	15	15	10	10	10	10		
Rated maximum current	gL-gG	A	25	25	32	32	50	50	80	80	80	125	125	160	200	250	315	400	630	800	1000	2x800		
Rated breaking capacity	400V; cos φ=0,45	A	80	100	160	200	256	320	504	504	504	640	640	1600	1450	2000	2240	1450	1450	1450	1450	1450		
Rated short-time withstand current (1 sec)		A	240	400	500	650	725	800	1600	1600	1600	2500	2500	3500	4400	4400	4400	6000	7000	7600	8000	8200		
Mechanical durability (thousand of operations)			1000	1000	1000	1000	1000	1000	1000	1000	1000	1000	1000	-	-	-	-	-	-	-	-	-		
Mechanical durability (number of operations)			-	-	-	-	-	-	-	-	-	-	-	30000	30000	30000	30000	30000	30000	30000	30000	30000		
Maximum connection capacity																								
Rigid copper conductor		mm <sup>2</sup>	2x4	2x4	2x6	2x6	2x10	2x10	16/25 <sup>*(2)</sup>	16/25 <sup>*(2)</sup>	16/25 <sup>*(2)</sup>	35/50 <sup>*(2)</sup>	35/50 <sup>*(2)</sup>	95	95	120	185	-	-	-	-	-		
Flexible copper conductors		mm <sup>2</sup>	2x2,5	2x2,5	2x4	2x4	2x6	2x6	10/16 <sup>*(2)</sup>	10/16 <sup>*(2)</sup>	10/16 <sup>*(2)</sup>	16/35 <sup>*(2)</sup>	16/35 <sup>*(2)</sup>	95	95	120	185	-	-	-	-	-		

According to UL508 - CAN / CSA C22.2 N° 14			Size 0				Size 1				Size 2				Size 3							
			T12	T20	T16	T25	T32	T40	T50	T63	T80	T100	T125	T175	T200	T250	T315	T400	T630	T800	T1250	T1600
Rated thermal current	Ith	A	12	20	16	25	32	40	63	63	63	100	100	200	200	200	400	630	800	-	-	
General use rating		A	12	20	16	25	32	40	63	63	63	100	100	200	200	200	200	200	200	-	-	
		Vac	300	300	600	600	600	600	600	600	600	600	600	600	600	600	600	600	600	600	-	-
AC rated operational power	3x240V	HP	2	5	5	7,5	10	15	20	20	20	30	30	25	60	60	60	60	60	-	-	
	3x480V	HP	-	-	10	15	20	25	40	40	40	50	50	60	75	75	75	75	75	-	-	
	3x600V	HP	-	-	10	15	20	25	40	40	40	50	50	50	60	60	60	60	60	-	-	

\*(1) 500V size "0" \*(2) With extension terminals \*(3) With phase barriers

### Normal service conditions\*

- Ambient air temperature (°C): -5°...+40°.
- Maximum altitude: 2.000 m.
- Maximum humidity: 90%.
- Pollution degree: 3 (standard for industrial applications).
- Rated frequency at AC utilization categories: 50/60 Hz.

- Rated duties at utilization categories AC21A, AC22A y AC23A: Continuing (8 hours); uninterrupted.
- Rated duties at utilization categories AC3 and AC4: Intermittent; temporary
- Switching direct currents: For L/R<50msg, rated operational current (Ie) can be dealt with up to 30Vdc. With higher voltages, several contacts have to be connected in series.

\* Please consult for other service conditions.

Approvals T:



According to IEC 60947-3			Size 0						
			TB20	TB25	TB32	TF12	TF16	TF25	
Rated thermal current	Ith	A	20	25	32	20	25	32	
Rated insulation voltage	Ui	V	500	500	500	690	690	690	
Rated impulse withstand voltage	Uimp	kV	6	6	6	6	6	6	
			Ue						
AC rated operational current	Ie	Ue 415V AC21A	A	20	25	32	20	25	32
		Ue 415V AC22A	A	20	25	32	20	25	32
		Ue 415V AC23A	A	20	25	32	-	-	-
AC rated operational power (Rated operational frequency 50/60 Hz)	Pe	3x240V AC23A	kW	5,4	6,7	8,6	4	5,5	7,5
		3x240V AC3	kW	3,7	4,6	5,9	4	5,5	5,5
		3x240V AC4	kW	2,9	3,7	4,6	1,5	2,2	3
		1x240V AC3	kW	2,1	2,7	4	2,2	3	4
		1x240V AC4	kW	1	1,25	1,5	0,55	0,75	1,1
		3x415V AC23A	kW	9,3	11,7	15	7,5	11	11
		3x415V AC3	kW	6,4	8	10,3	5,5	7,5	7,5
		3x415V AC4	kW	3,1	3,8	5,5	3	4	5,5
		1x400V AC3	kW	3,6	4,5	5,7	3	4	5,5
		1x400V AC4	kW	1,7	2,2	3	1,1	1,5	1,5
Rated conditional short-circuit current		kA	5	5	5	5	5	5	
Rated maximum current	gL-gG	A	35	35	35	20	25	32	
Rated breaking capacity	400V; cos φ=0,45	A	160	200	256	100	160	200	
Rated short-time withstand current (1 sec)		A	240	400	500	350	400	500	
Mechanical durability (thousand of operations)			1000	1000	1000	1000	1000	1000	
Maximum connection capacity									
Rigid copper conductor		mm <sup>2</sup>	1x10	1x10	1x10	1x10	1x10	1x10	
Flexible copper conductors		mm <sup>2</sup>	1x6	2x4	1x6	2x4	1x6	1x6	

According to UL508 - CAN / CSA C22.2 N° 14			Size 0					
			TF12	TF16	TF25			
Rated thermal current	Ith	A	-	-	-	16	20	25
General use rating		A	-	-	-	16	20	25
		Vac	-	-	-	600	600	600
AC rated operational power	3x240V	HP	-	-	-	2	5	7,5
	3x480V	HP	-	-	-	5	10	12
	3x600V	HP	-	-	-	5	10	15

Approvals TB:



Approvals TF:



Approvals TP:







14 15 16  
D100 4



Light with white neon lamp  
D100

14 15 16  
D101 5



Light with white neon lamp  
and inscription plate  
D101

**D101** Inscription plate included with text as requested.

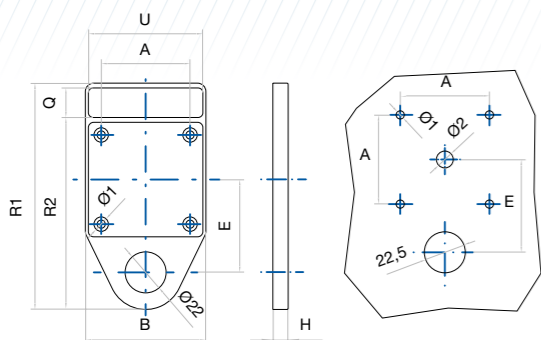

Supply	Size	For series	Code D100	Code D101
Spare or incorporated in the cam switch	0-1	T12-T20-TB20-TB25-TB32 TF12-TF16-TF25 T16-T25-T32-T40	DT-10011	DT-10111
	2	T50-T63-T100-T175	DT-10021	DT-10121
	3	T200	DT-10031	DT-10131

Series	B	R1	R2	H	E	U	Q	A	Ø1	Ø2
T12 T20 T16 T25 T32 T40 TB20 TB32 TF12 TF25	65	123	102	6,5	50	61	16	48	4,5	9
T50 T63 T100 T175	94	160	137	7,5	70	90	19	68	5,5	12
T200 T800	132	198	173	10	85	126	21	108	6,5	16

13 14 15 16  
D200 D  
13 14 15 16  
D201 E



Tandem drive operation\*  
D200 with two columns  
D201 with three columns

13 14 15 16  
D300 F  
13 14 15 16  
D301 G



Blocking operation\*  
D300 with two columns  
D301 with three columns

Supply	Size	For series
Only incorporated in the cam switch	0-1	T12-T20-TF12-TF16-TF25 T16-T25-T32-T40
	2	T50-T63-T100
	3	T175-T200

\* T Series (without IP20 protections).

Series	Tandem		Blocking		A	B	D	R	U	Q	E	H	Ø	
	D200	D300	D201	D301										
T12 T20 T16 T25 T32 T40 TF12 TF16 TF25	D200	D300	D201	D301	56	70	143	157	64	128	67	22	22	4,5
T50 T63 T100	D200	D300	D201	D301	90	110	210	230	95	191	288	97	15	21
T175 T200	D200	D300	D201	D301	152	173	290	310	132	270	407	139	19	25

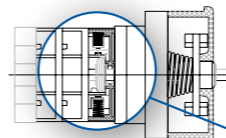
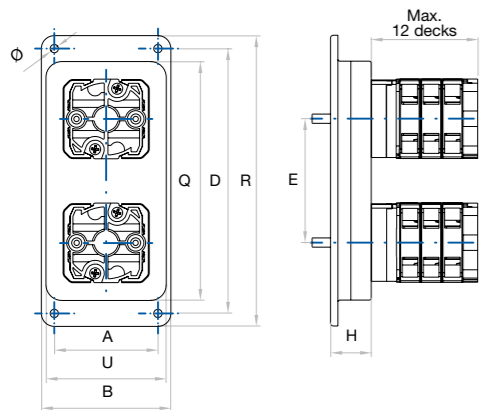

13 14 15 16  
H

Push to turn  
D401\*

Before operating the handle must be pressed to unlock, simultaneously an auxiliary contact it is open or closed (e.g. for switching without load).

Supply	Size	For series
Only incorporated in the cam switch	0	T12-T20-TB20-TB25-TB32
	1	T16-T25-T32-T40

\* for arrow handle with indicator, other combinations with special scheme



Locking voltage device  
D420

The screw position, left or right, prevents the rotation of the handle.

This device always includes a mounting plate size 1.

Supply	Size	For series
Only incorporated in the cam switch	0-1	T12-T20-TB20-TB25-TB32 TF12-TF16-TF25 T16-T25-T32-T40

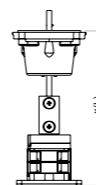

Shaft extension

To extend the shaft length to the depth required. To be complemented with the corresponding D501 device.

Supply	Size	Length (mm)	For series	Code
Spare or incorporated in the cam switch	0-1	200	T12-T20-TB20-TB25-TB32 TF12-TF16-TF25 T16-T25-T32-T40	DT-EPR11
		500		DT-EPR12
	2	200	T50-T63	DT-EPR21
		500	T100-T175	DT-EPR22
Only incorporated in the cam switch	3	upon request	T200	-

\*L1 Specify total length when ordering

13 14 15 16  
I

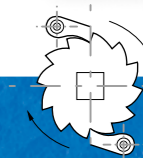

One way rotation  
D405

This device allows to rotate the handle in only one way.

Supply	Size	For series
Only incorporated in the cam switch	0-1	T12-T20-TB20-TB25-TB32 TF12-TF16-TF25 T16-T25-T32-T40



Clutch device with door interlock  
D501

With door interlock in ON position (switch 0-1 to 90°) or according to the electrical diagram.

- 1 Size 0 with padlockable handle included.
- 2 Size 0 - 1 - 2 - 3.

Supply	Size	For series	Code
Spare	D501 + 704 90°	0	T12-T20 TB20-TB25-TB32 TF12-TF16-TF25
			DT-75401N07 DT-75401R01 F 6 N 1 F 6 R D
Incorporated in the cam switch	90°	0	DT-50102
		1	DT-50101
		2	DT-50121
Spare	60°	0-1	DT-50104
		2	DT-50124
		3	DT-50134
Incorporated in the cam switch	45°	0-1	DT-50103
		2	DT-50123
		3	DT-50133



Coaxial coupling  
**D600**



Simultaneous operation with only one handle of two or more cam switches (T series) with different ratings coupled together.

Key handle device  
**D701**



**D701** Supplied as standard with ø22mm fixing; ø30 mm also available under request.

The key can be locked and removed on request at 60°, 90° or 180°.

Assembly limitation:  
4 contacts actuating simultaneously.

**D711** Supplied as standard with screw mounting and different types of keys that can be locked and removed at 90°.

Assembly limitation:  
4 contacts actuating simultaneously.

Key handle device  
**D711**



Supply	Size	For series
Only incorporated in the cam switch	0-1	T12-T20-TB20-TB25-TB32 TF12-TF16-TF25 T16-T25-T32-T40

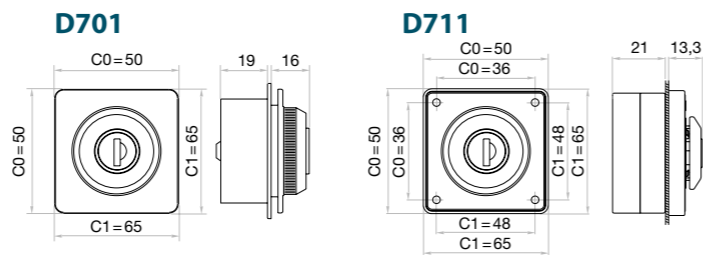

Key lock device  
**D702**



**D702** The key lock device allows the adaptation of 1 or 2 auxiliary contacts (1NO + 1NC) operated by turning the key (like signalling or control contacts).

**D703** Inscription plate included with text as requested.

Key lock device with inscription plate  
**D703**



Supply	Size	For series
Only incorporated in the cam switch	0-1	T12-T20-TB20-TB25-TB32 TF12-TF16-TF25 T16-T25-T32-T40
	2	T50-T63 T100-T175
	3	T200

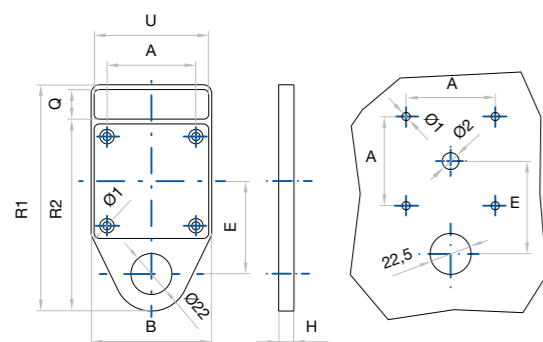

\* Auxiliary contacts 1NO + 1NC

Series	B	R1	R2	H	E	U	Q	A	Ø1	Ø2
T12 T20 T16 T25 T32 T40 TB20 TB32 TF12 TF25	65	123	102	6,5	50	61	16	48	4,5	9
T50 T63 T100 T175	94	160	137	7,5	70	90	19	68	5,5	12
T200 T800	132	198	173	10	85	126	21	108	6,5	16

Padlockable handle  
**D704**



- Allows the blockade of the handle in OFF position using padlock.
- Available in red colour on yellow background <sup>15</sup>R or black colour on grey background <sup>15</sup>N
- According to the machinery directive and the european standards, red & yellow handles <sup>15</sup>R are intended to be used only in ON - OFF safety switches.
- For switches O-I specify version <sup>15</sup>R or <sup>15</sup>N, for the rest will be supplied <sup>15</sup>N version (padlocks not included).

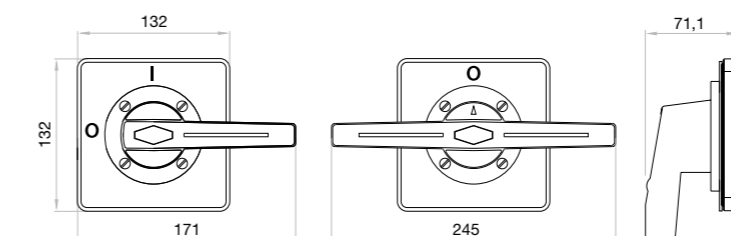
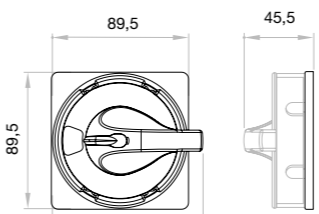
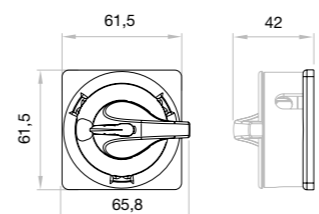
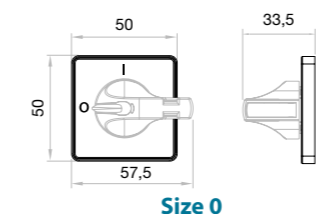

	Supply	Size	For series	Code
Square plate	Spare	0	T12-T20 TB20-TB25-TB32 TF12-TF16-TF25 TP10	DT-70401N07
	Incorporated in the cam switch			DT-70401R01*
Closed view	Spare	0-1	T12-T20 TB20-TB25-TB32 TF12-TF16-TF25 T16-T25-T32-T40	DT-7041CN02
	Incorporated in the cam switch			DT-7041CR02
Open view	Spare	0-1	T12-T20 TB20-TB25-TB32 TF12-TF16-TF25 T16-T25-T32-T40	DT-7041AN02
	Incorporated in the cam switch			DT-7041AR02
Closed view	Spare	2	T50-T63 T100-T175	DT-7042CN02
	Incorporated in the cam switch			DT-7042CR02
Open view	Spare	2	T50-T63 T100-T175	DT-7042AN02
	Incorporated in the cam switch			DT-7042AR02
Square plate (single handle)	Spare	3	T200	DT-70431
	Incorporated in the cam switch			DT-70433*
Square plate (double handle)	Spare	3	T200	DT-70432
	Incorporated in the cam switch			DT-70434*

\*Yellow plate with 0 - 1 positions included



**Padlockable handle with inscription plate D705**



- Handle can be blocked in OFF position using padlocks.
- Available in red colour on yellow background <sup>15</sup>R or black colour on grey background <sup>15</sup>N
- Inscription plate included with text as requested.
- According to the machinery directive and the european standards, red & yellow handles <sup>15</sup>R are intended to be used only in ON-OFF safety switches.
- For switches O-I specify version <sup>15</sup>R or <sup>15</sup>N, for the rest will be supplied <sup>15</sup>N version (padlocks not included).

	Supply	Size	For series	Code
● Closed view	Only incorporated in the cam switch	0-1	T12-T20	13 14 15 16 <b>7 N 2</b>
			TB20-TB25-TB32 TF12-TF16-TF25	13 14 15 16 <b>7 R 2</b>
○ Open view	Only incorporated in the cam switch		T16-T25 T32-T40	13 14 15 16 <b>C N 2</b>
				13 14 15 16 <b>C R 2</b>
● Closed view	Only incorporated in the cam switch	2	T50-T63 T100-T175	13 14 15 16 <b>7 N 2</b>
				13 14 15 16 <b>7 R 2</b>
○ Open view	Only incorporated in the cam switch			13 14 15 16 <b>C N 2</b>
				13 14 15 16 <b>C R 2</b>
□ Square plate (single handle)	Only incorporated in the cam switch	3	T200	13 14 15 16 <b>N N 2</b>
□ Square plate (double handle)	Only incorporated in the cam switch			13 14 15 16 <b>N R 2</b>
				13 14 15 16 <b>O N 2</b>
				13 14 15 16 <b>O R 2</b>

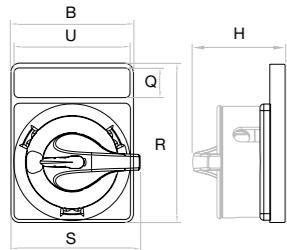

Size	B	H	Q	R	S	U
0-1	6,5	48,5	16	85	65,8	61
2	9,4	53,5	19	117	98,8	90
3	13,2	71,5	21	157	171	126

14 15 16  
D708 **8**



**Push button blocking system D708**

**D708** Available in two versions (specify when ordering):

- The handle is blocked in all positions.
- The handle is blocked only in OFF position.

The switch in version 2 can be used for emergency operation since the handle is not blocked in ON position. Both versions admit the adaptation of 1 and 2 changeover auxiliary contacts (1NO+1NC), which are activated when the button is pressed and it can be used as signalling and combined operation with contactors.

**D709** Inscription plate included with text as requested.

14 15 16  
D709 **9**



**Push button blocking system with inscription plate D709**

Supply	Size	For series
Only incorporated in the cam switch	0-1	T12-T20-TB20-TB25 TB32-TF12-TF16-TF25 T16-T25-T32-T40
	2	T50-T63-T100-T175
	3	T200

\* Auxiliary contacts 1NO + 1NC 2NO + 2NC



Series	B	R1	R2	H	E	U	Q	A	Ø1	Ø2
T12 T20 T16 T25 T32 T40 TB20 TB32 TF12 TF25	65	123	102	6,5	50	61	16	48	4,5	9
T50 T63 T100 T175	94	160	137	7,5	70	90	19	68	5,5	12
T200 T800	132	198	173	10	85	126	21	108	6,5	16

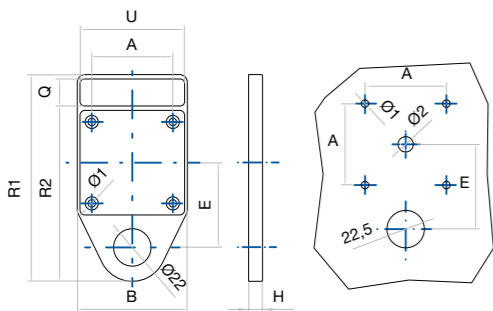

**Return from one or two ways up to 120° D802**

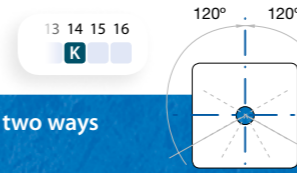

Supply	Size	For series
Only incorporated in the cam switch	0-1	T12-T20-TB20-TB25-TB32 TF12-TF16-TF25 T16-T25-T32-T40

**Terminal shrouds D900**

Sizes 0-1 and 2 are supplied as standard with removable protected terminals (IP20).

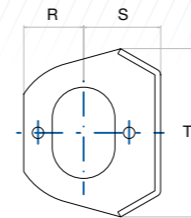

Series	R	S	S
T12 T20	21	27	59
T16 T25 T32 T40	28	34	72
T50 T63 T100	15	52	104
T200	40	155	130

Supply	Size	For series	Code
	0	T12-T20	DT-90002
	1	T16-T25-T32-T40	DT-90012
Spare	2	T50-T63	DT-90022
		T100	DT-90024
	3*	T200	DT-90031
		T400	DT-90032

\* Max. 2 chambers

**T175 terminal shrouds and phase barriers D900**

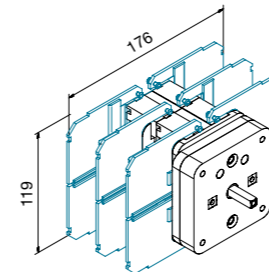

**Phase barriers - Vertical**  
Code DT-90025 (4 units)

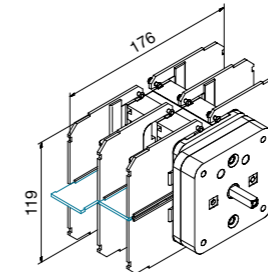

**Phase barriers - Horizontal**  
Code DT-90026 (2 units)

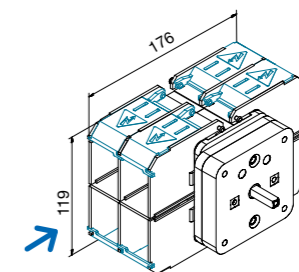

**Terminal shrouds (L)**  
Code DT-90027 (4 units)

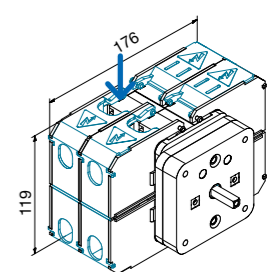

**Terminal shrouds (S)**  
Code DT-90028 (4 units)

**DIN rail mounting device D904**

**D904** Included as standard in D-F-G fixing types for TB-TF and T175 series.

**D905** DIN rail mounting with frontal plate and handle for distribution boards.

**Front plates for distribution boards D905**

	Supply	Size	For series	Code
D904	Spare or incorporated in the cam switch	0-1	T12-T20-T16 T25-T32-T40	DT-90401
		2	T50-T63-T100-T175	DT-90421
D905	Only incorporated in the cam switch	0	T12-T20 TF12-TF16-TF25	12 13 14 15 16 <b>H 3 N O</b>

Handles (plastic)

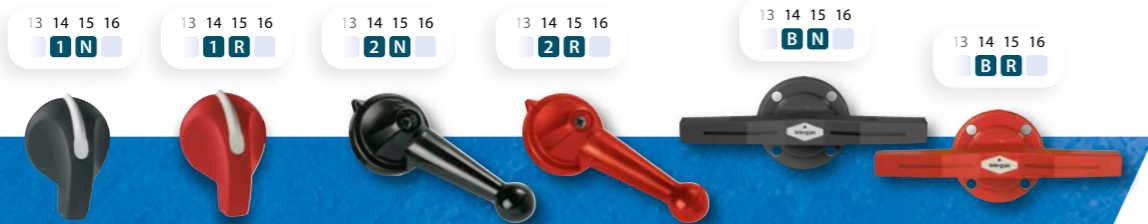

- 14 **1** Arrow handle with indicator.
- 14 **2** Ball lever handle for size 1 and 3.
- 14 **B** Double handle for cam switches size 3.

	Supply	Size	Code		
Arrow handle with indicator	Spare or incorporated in the cam switch	0	● 40110030 ● 40110031		
		1	● 40111034 ● 40111035		
		2	● 40112028 ● 40112029		
		3	● 40113023 ● 40113024		
		Ball lever	Spare or incorporated in the cam switch	1	● 40111002 ● 40111003
				3	● 40113002 ● 40113001
Double handle	Spare or incorporated in the cam switch			3	● 40113008 ● 40113007

Arrow handle with indicator (sizes 0 - 1 - 2 - 3)

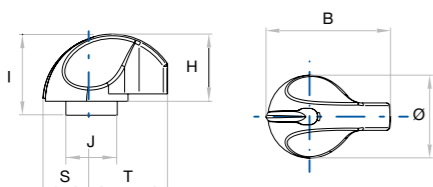

Size	B	H	I	J	S	T	Ø
0	39,3	26,8	30,5	14,5	13,5	24	27
1	50	28	33	14,5	18	32	36
2	66,5	36,5	-	-	22,5	44	45
3	100	54	-	-	38	62	76

Ball lever (sizes 1 - 3)

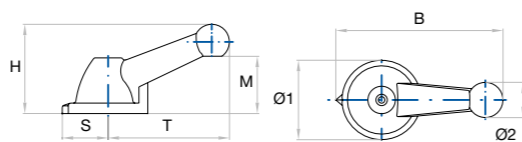

Size	B	H	S	T	M	Ø1	Ø2
1	89	48	24	65	32,5	37	18
3	151,5	81	41,5	110	52	72	32

Double handle (size 3)

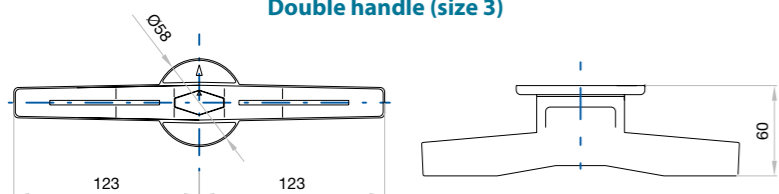

Handles (metal & plastic)

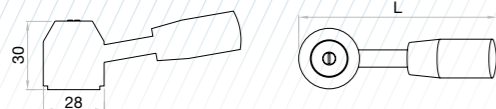

	Supply	Size	Code
Metal lever & plastic	Spare or incorporated in the cam switch	L=90mm	9-KN100146
		L=108mm	9-KN100145

Neutral name plates and neutral inscription plates



- Plastic indicating plate on square base with black engraving
- Also in yellow colour available (emergency handle).
- Different engravings are available under request.
- PPA model with inscription plate.

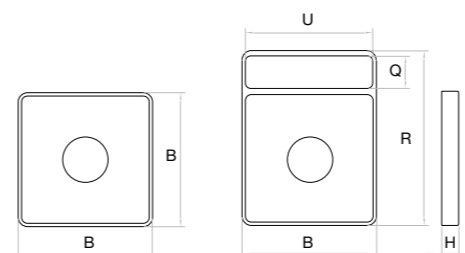

PPA

PRA

Size	B	R	H	U	Q
0	50	65	6,5	47	11
1	65	85	6,5	61	16
2	94	117	7	90	19
3	132	157	10	126	21

	Supply	Size	Code
PPA (neutral plate)	Spare or incorporated in the cam switch	0	■ 40140045 ■ 40140061 ■ 40110028
		1	■ 40141039 ■ 40141053 ■ 40111032
		2	■ 40142020 ■ 40142028 ■ 40142025
		3	■ 40143020 ■ 40143028 ■ 40143084
PRA (neutral plate)	Spare or incorporated in the cam switch	0	■ 40140203 ■ 40110029
		1	■ 40141188 ■ 40111033
		2	■ 40142095 ■ 40112026
		3	■ 40143088 ■ 40143086

Terminal extensions CP

Supply	Size	For series
Only incorporated in the cam switch	0	T12-T20
	1	T16-T25-T32-T40
	2	T50-T63-T100

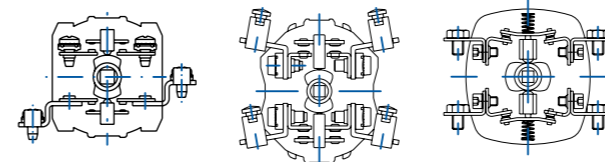

T12-T16-T20-T25

T32-T40-T63-T100

T200 standard connection as per drawing

Fast-on terminals 6,25 x 0,8

Supply	Size	For series
Only incorporated in the cam switch	0-1	T12-T20 T16-T25-T32-T40





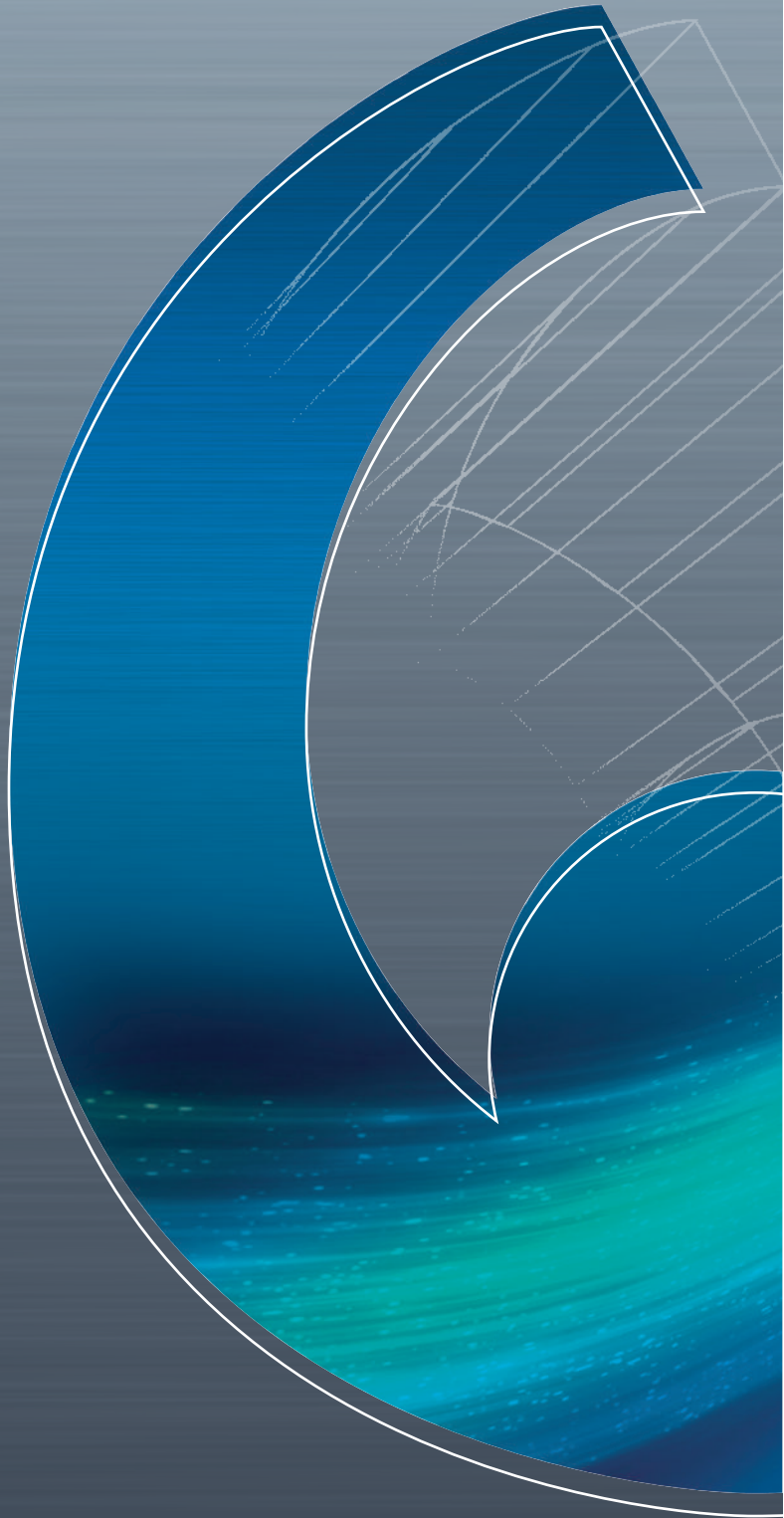

**Telergon, S.A.U.**  
Ctra. Castellón (Pol. La Cartuja)  
50720 La Cartuja Baja  
Zaragoza / España



Tel.: + 34 976 500 876  
comercial@telergon.com  
www.telergon.com