

F7 Series
DC Switch-disconnector

▶ **CODE**

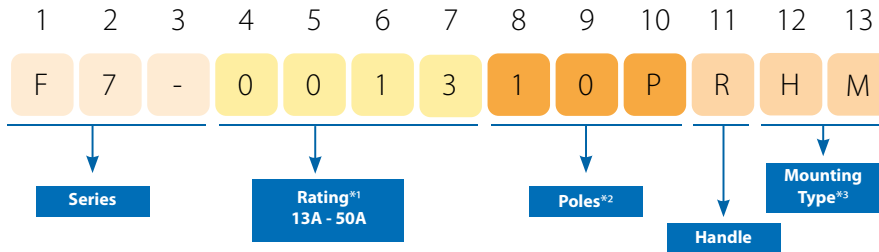

▶ **PRODUCT BENEFITS**

- Up to 55A.
- Modular design, available 2 up to 10 levels.
- Dynamic sealing design and materials for an IP66 protection.
- DC 1500V insulation voltage and operation.
- IEC/EN60947-3, AS60947.3, UL508i (File UL E362647), GB/T14048.3
- TUV, CE, CB, SAA, UL, CCC standards.
- *3 **Mounting Type**: DIN Rail (DB), Panel Mounting (PM), Door Interlock (DC), Hole Mounting (HM).

▶ **POLES AND CONFIGURATIONS***2

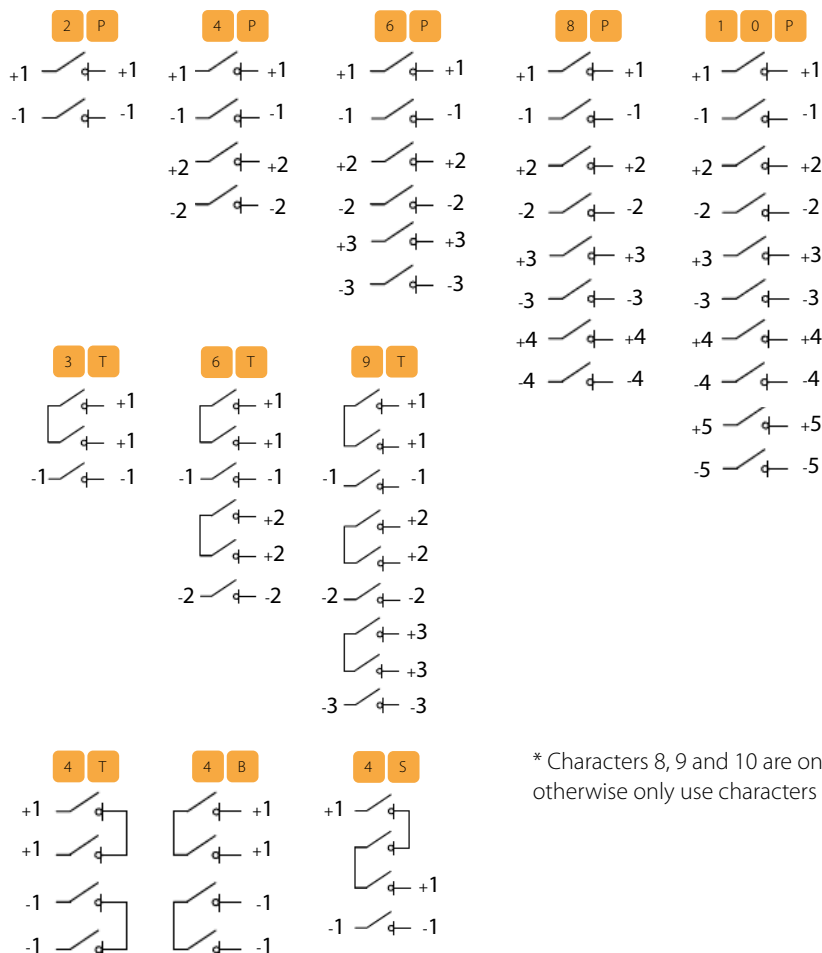
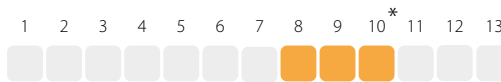

* Characters 8, 9 and 10 are only used when it's 10P, otherwise only use characters 8 and 9.



series **F7**

DIN-Rail Mounting

D B



Panel Mounting

P M

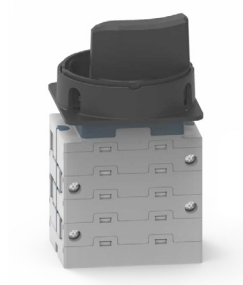

Door Interlock

D C



Hole Mounting

H M

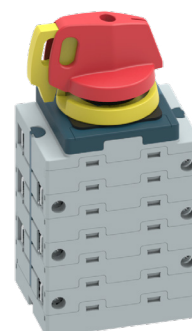

► TECHNICAL DATA



Poles and configurations*2	Voltage / current (DC-PV1)					
	*1	600Vdc	800Vdc	1000Vdc	1200Vdc	1500Vdc
2P/4P/6P/8P/10P	0013	32A	26A	13A	10A	5A
	0020	40A	30A	20A	12A	6A
	0025	55A	45A	25A	15A	8A
	0030	55A	55A	50A	40A	32A
3T/6T/9T	0013	32A	32A	32A	23A	10A
	0020	40A	40A	40A	30A	13A
	0025	55A	55A	55A	40A	20A
	0030	55A	55A	55A	50A	40A
4T/4B/4S	0013	32A	32A	32A	26A	13A
	0020	40A	40A	40A	30A	20A
	0025	55A	55A	55A	40A	30A
	0030	55A	55A	55A	55A	50A

Poles and configurations*2	Voltage / current (DC-PV2)					
	*1	600Vdc	800Vdc	1000Vdc	1200Vdc	1500Vdc
2P/4P/6P/8P/10P	0013	32A	26A	13A	10A	5A
	0020	40A	30A	20A	12A	6A
	0025	40A	40A	25A	15A	8A
	0030	55A	50A	40A	32A	18A
3T/6T/9T	0013	32A	32A	32A	23A	10A
	0020	40A	40A	40A	30A	13A
	0025	55A	55A	40A	32A	20A
	0030	55A	55A	55A	45A	36A
4T/B/S	0013	32A	32A	32A	26A	13A
	0020	40A	40A	40A	30A	20A
	0025	55A	55A	40A	32A	25A
	0030	55A	55A	45A	45A	36A

Poles and configurations*2	Voltage / current (UL 508i file UL E362647)					
	*1	600Vdc	800Vdc	1000Vdc	1200Vdc	1500Vdc
2P/4P/6P/8P/10P	0013	30A	25A	13A	10A	5A
	0020	40A	30A	20A	13A	5A
	0025	40A	40A	25A	16A	10A
	0030	40A	40A	30A	16A	16A



► TECHNICAL DATA

According to IEC/EN60947-3,AS60947.3:2018, UL508i, GB/T14048.3, Utilization category DC-PV1/DC-PV2

CODE		A	0013	0020	0025	0030
Rated insulation voltage	Ui	V	1500	1500	1500	1500
Rated thermal current	Ith	A	32	40	55	55
Rated impulse withstand voltage	Uimp	V	8000			
Rated short-time withstand current (1s)	Icw	A	780			
Rated short-time making capacity	Icm	A	1200			
Maximum cable cross sections (incl. jumper)						
Rigid		mm ²	4-16			
Flexible		mm ²	4-16			
Flexible (+ multicore cable end)		mm ²	4-16			
Torque						
Tightening torque terminal screws M4		Nm	1.2-1.8			
Tightening torque single hole mounting nut M16		Nm	2.0-2.3			
Tightening torque handle screws M3		Nm	0.5-0.7			
Torque switch		Nm	0.9-1.3			
General parameters						
Number of operating cycles with load	Cycles		3000			
Number of operating cycles without load	Cycles		10000			
Distance of contacts (per pole)			8mm			
Operation temperature*			-40° to +85°			
Store temperature			-40° to +85°			
Pollution degree			3			
Overvoltage category			II			
IP rating (PM, DC, EA, EP)			IP66			

* UL up to 70°

1 2 3 4 5 6 7 8 9 10 11 12 13



► DIMENSIONS

DIN RAIL MOUNTING



Lockable

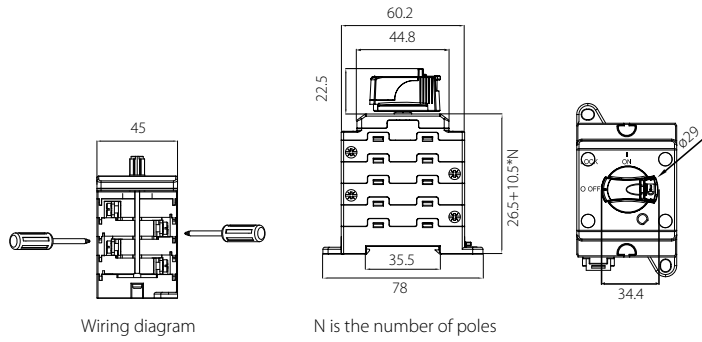

Wiring diagram

N is the number of poles

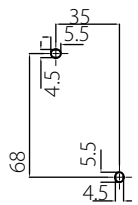

Screw mounting

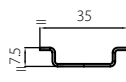

DIN mounting

PANEL MOUNTING



Lockable

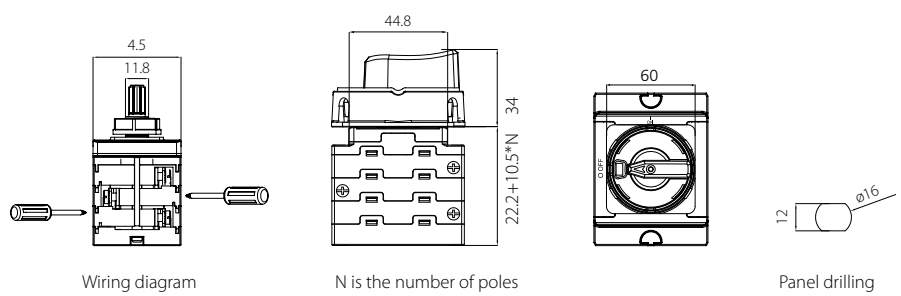

Wiring diagram

N is the number of poles

Panel drilling



► DIMENSIONS

DOOR INTERLOCK



Without lock



Lockable

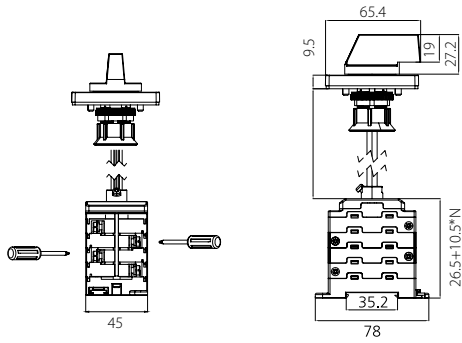

Wiring diagram

N is the number of poles

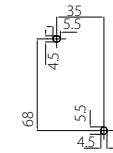

Screw mounting



DIN mounting

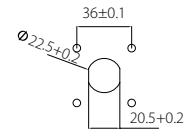

Panel drilling

HOLE MOUNTING



Without lock



Lockable

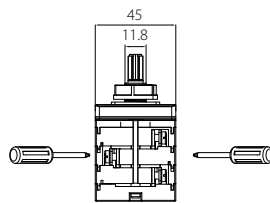
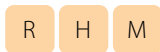

Wiring diagram

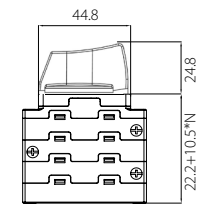

N is the number of poles

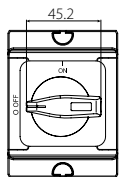

Panel drilling

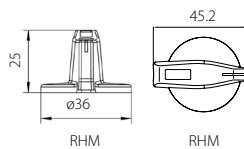

RHM

RHM

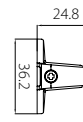

HM

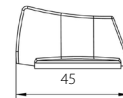

HM

